

NOTES:
1. ASSURE ASSEMBLY CAPABILITY BY MATCHING WITH MATING PART

REVISIONS			
REV.	DESCRIPTION	CHANGED BY	APPROVED BY
A1	PRODUCTION RELEASE	-	-
B1	.059 DIA HOLES MOVE TO OPPOSITE CORNERS	SDH	2021-07-07

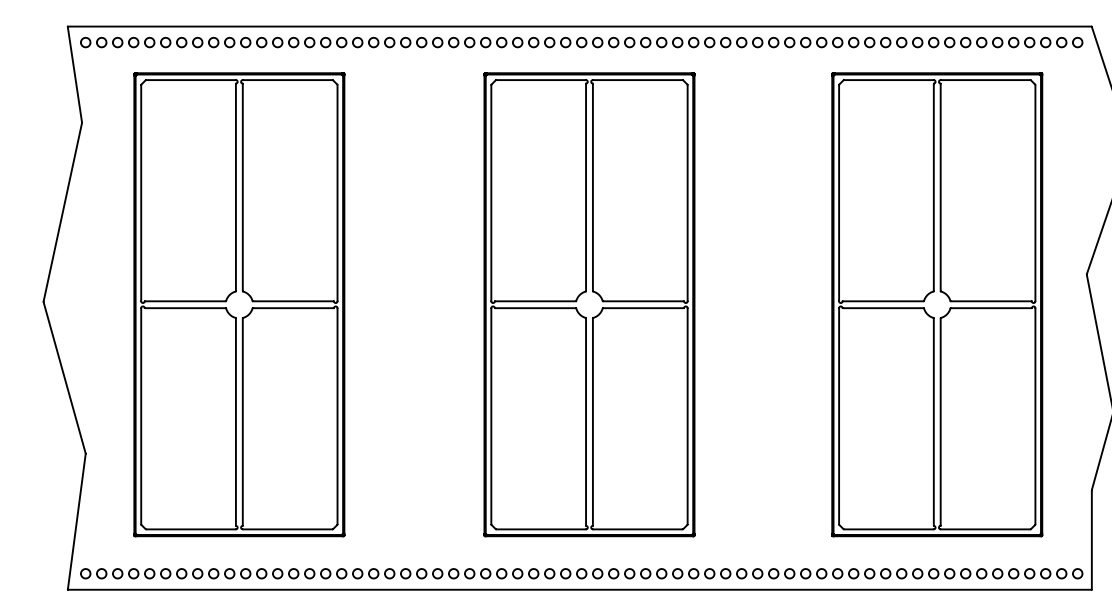
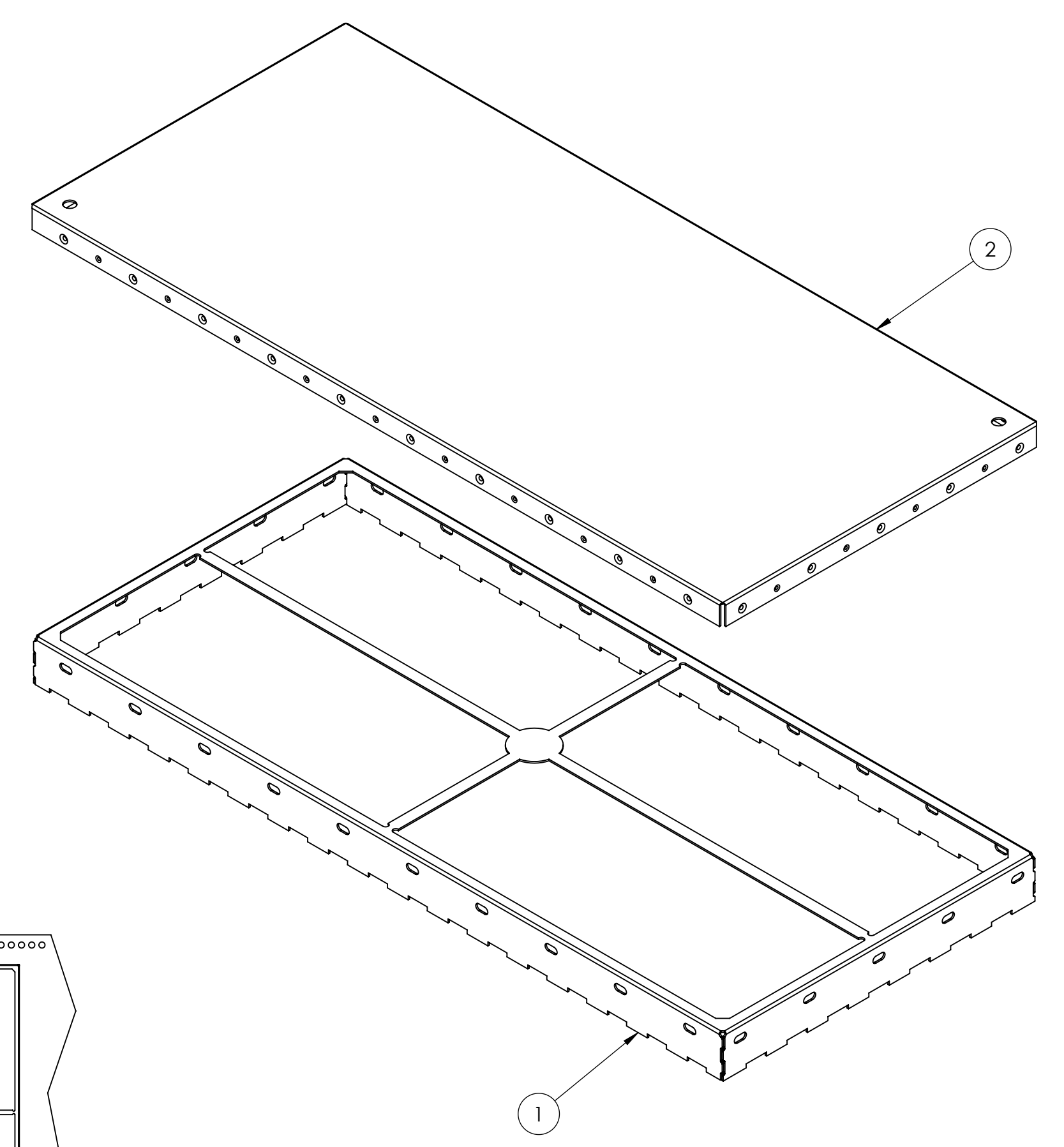
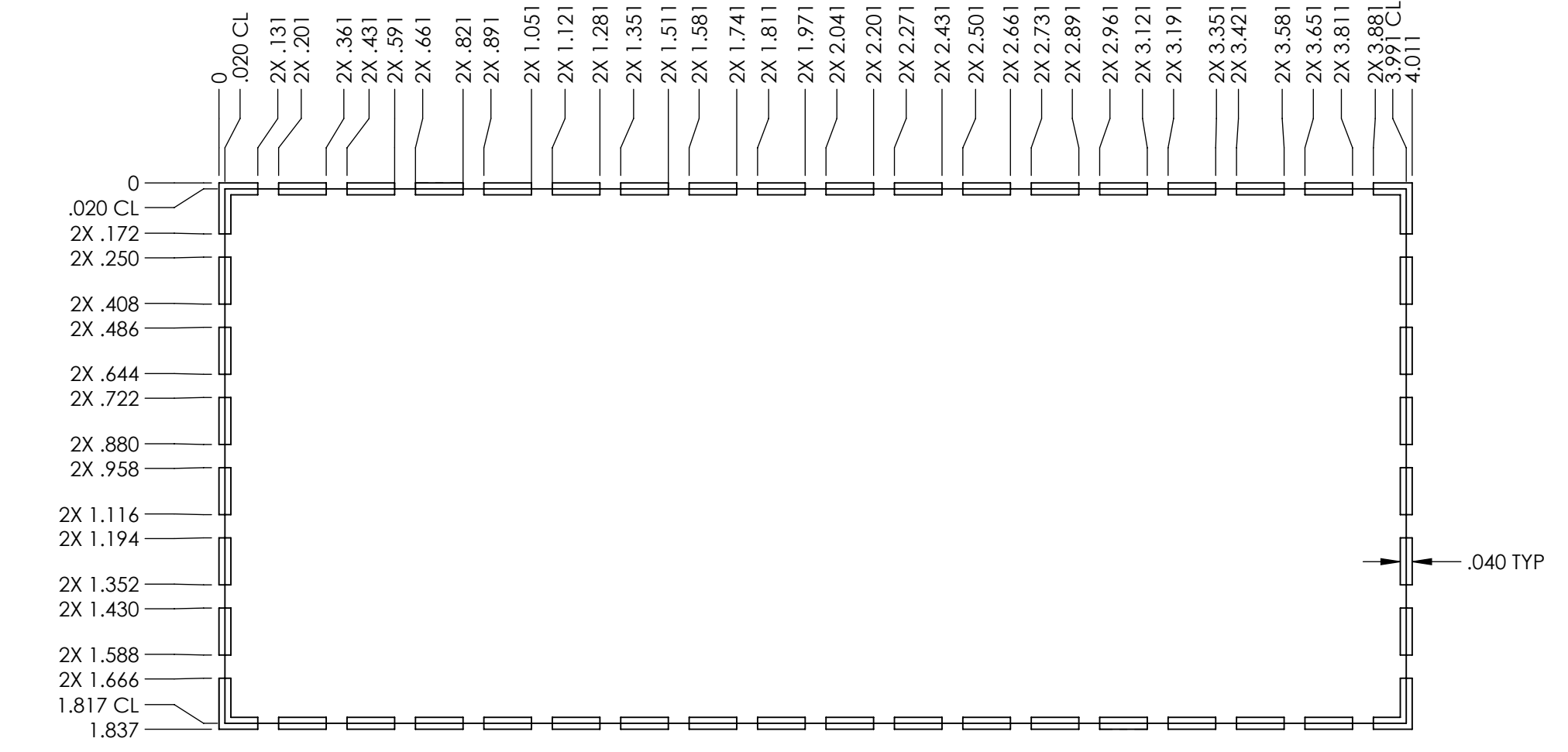
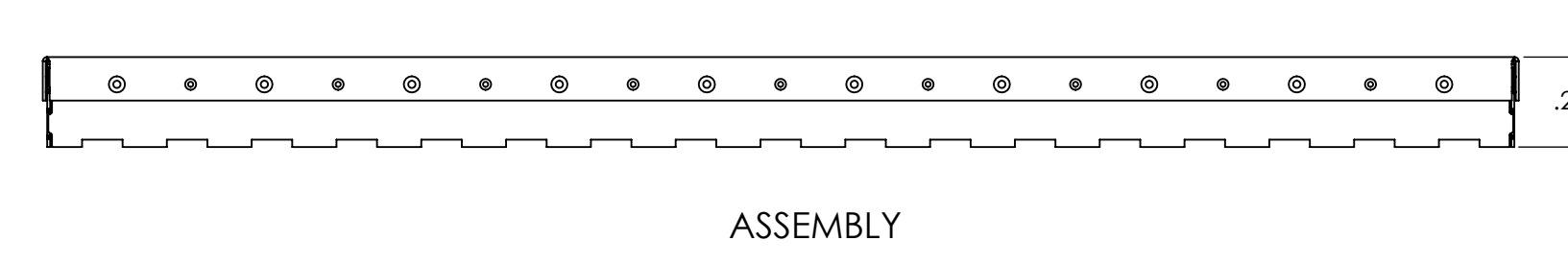
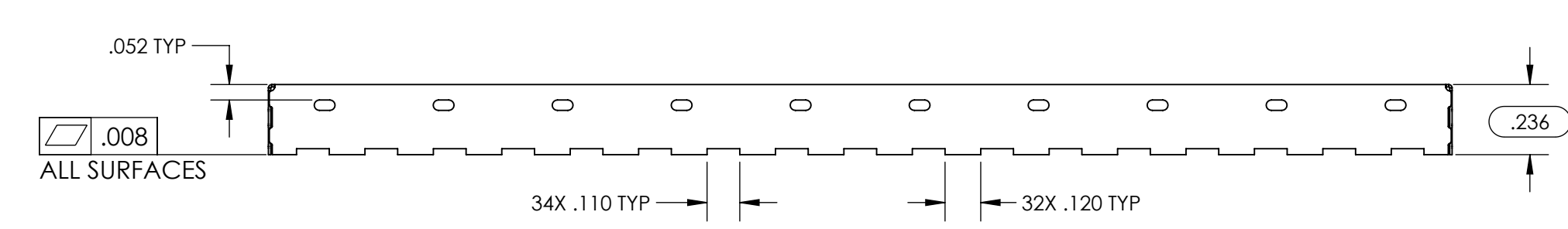
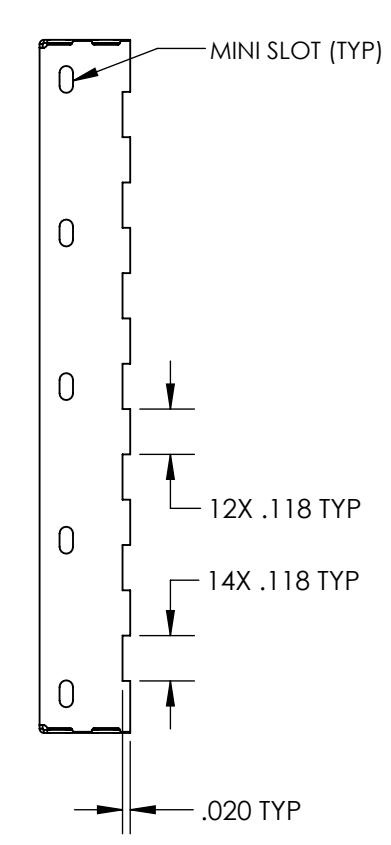
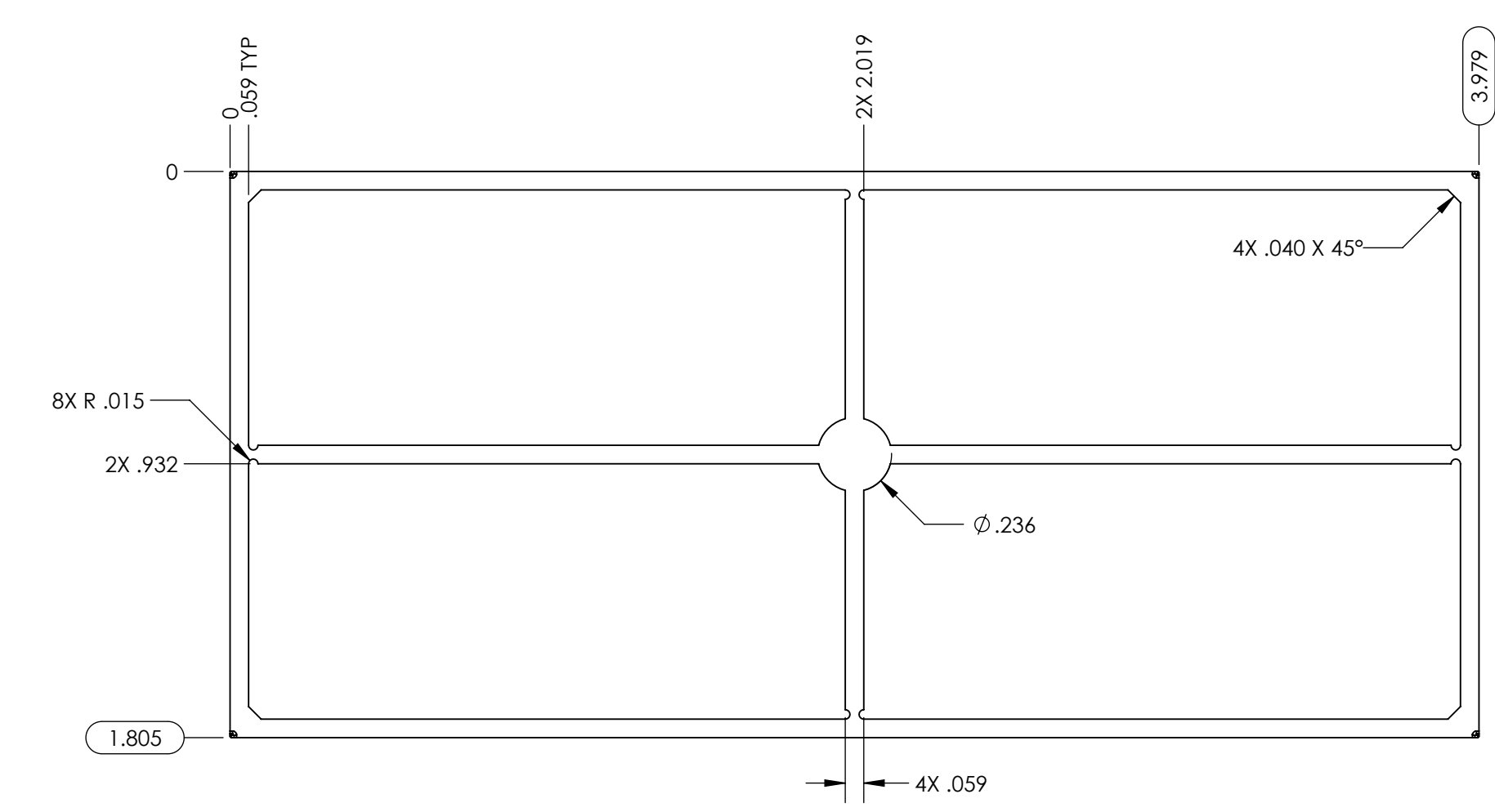
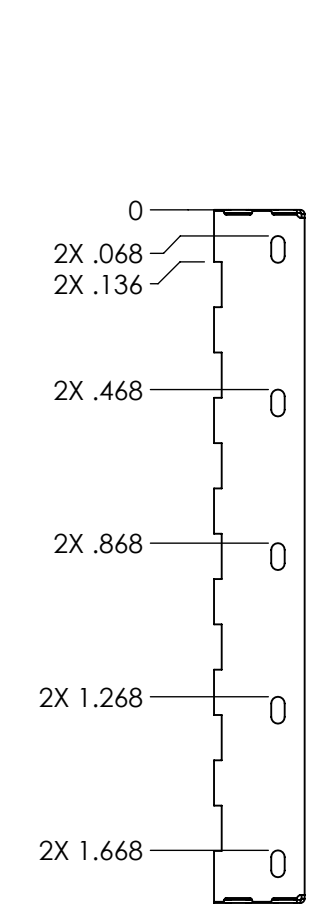
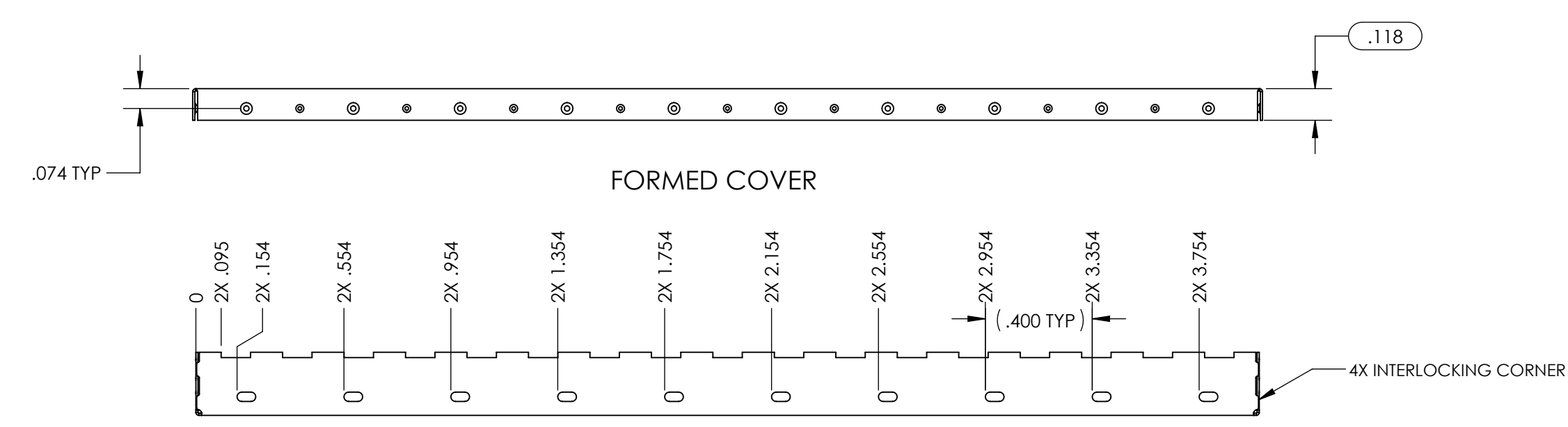
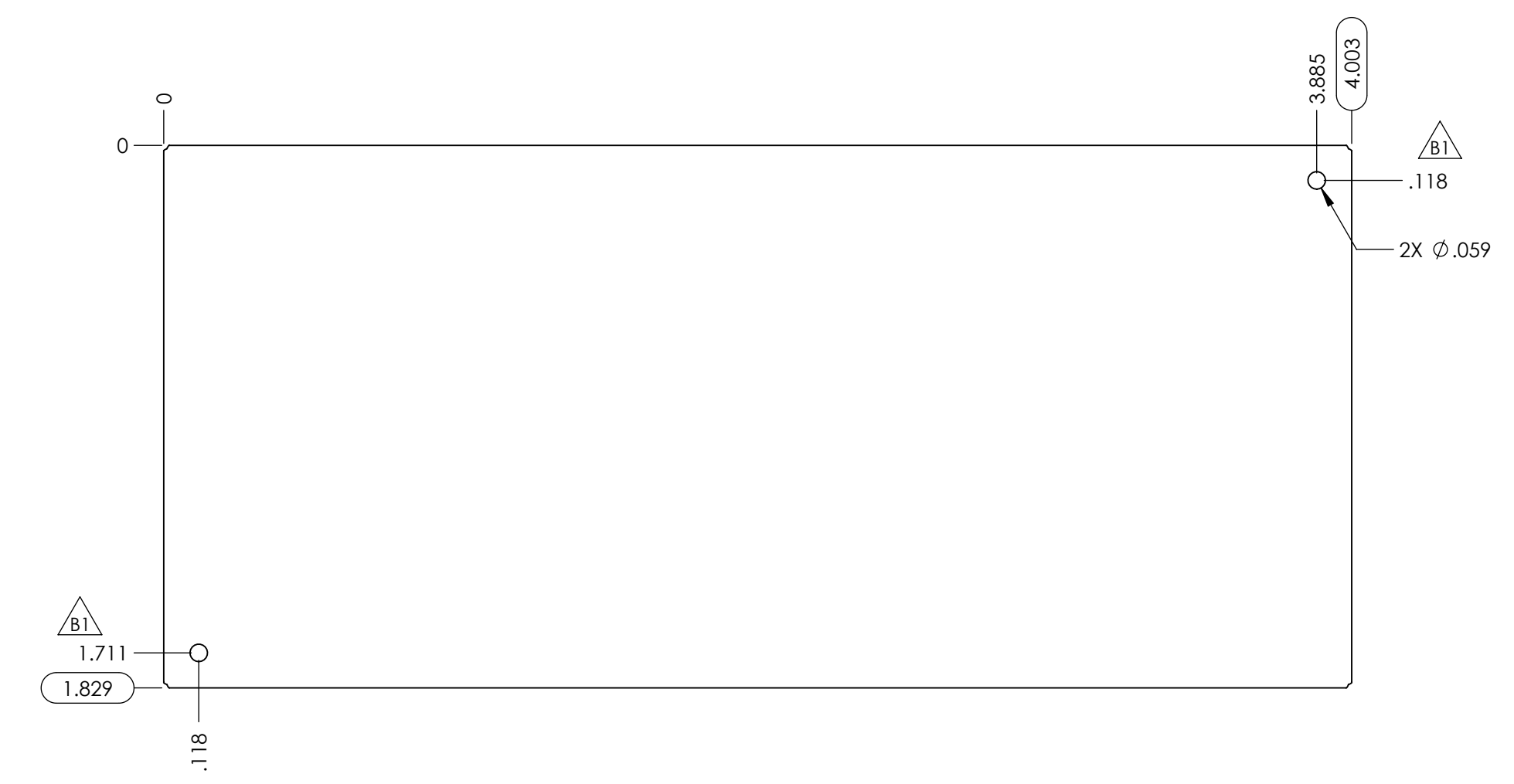
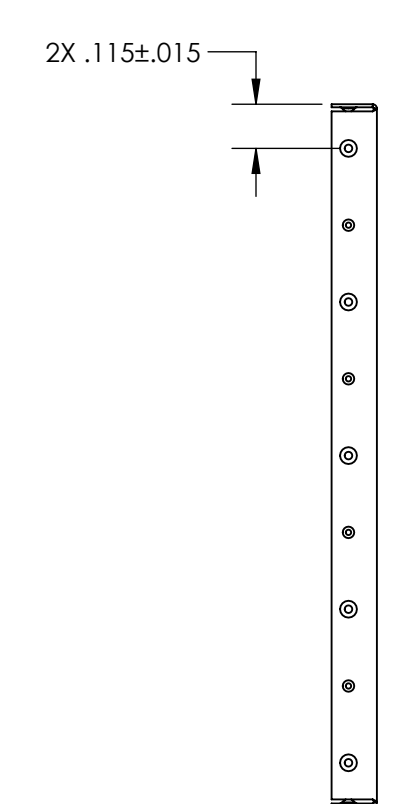
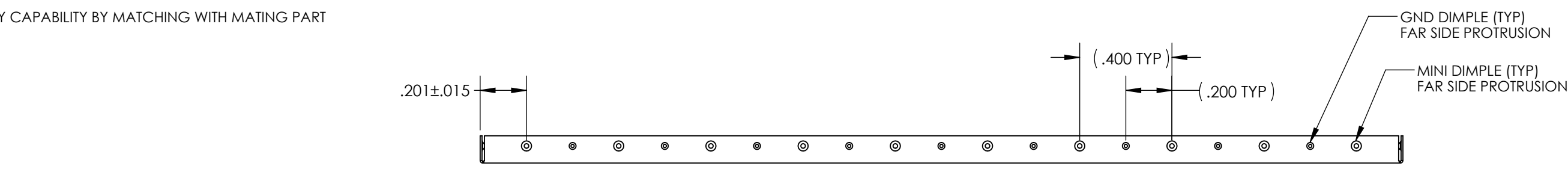

CARRIER TAPE SPECIFICATIONS						
PART NUMBER	DESCRIPTION	OVERALL DIMENSIONS	OVERALL HEIGHT	CARRIER TAPE WIDTH	CARRIER TAPE PITCH	PARTS PER REEL
SMS-463F	FRAME	1.805 X 3.979 [45.85 X 101.07]	.236 [5.99]	120 mm	56 mm	130
SMS-463C	COVER	1.829 X 4.003 [46.46 X 101.68]	.118 [3.00]	N/A	N/A	BULK PACK

THIS DOCUMENT CONTAINS PROPRIETARY INFORMATION OWNED BY LEADTECH OR DEVELOPED AT ITS OWN PRIVATE EXPENSE AND MAY NOT BE USED, DUPLICATED OR DISCLOSED IN WHOLE OR IN PART FOR ANY PURPOSE INCLUDING DESIGN, MANUFACTURE OR PROCUREMENT WITHOUT THE WRITTEN PERMISSION OF LEADTECH. LEADTECH DOES NOT GUARANTEE OR WARRANT THE PERFORMANCE CHARACTERISTICS.

ITEM NO.	PART NUMBER	DESCRIPTION	QTY.
1	SMS-463F	FRAME	1
2	SMS-463C	COVER	1

UNLESS OTHERWISE SPECIFIED:
- ALL DIMENSIONS ARE IN INCHES
- PART SHALL BE FREE OF BURRS AND SHARP EDGES
- ALL DIMENSIONS SHOWN APPLY AFTER PLATING AND COATINGS
- ROHS COMPLIANT PER EU DIRECTIVE 2011/65/EU
- POI = POINT OF INTERSECTION

THIRD ANGLE PROJECTION

LEADER TECH
a HEICO company
The Leading Edge in EMI Shielding Technology

TITLE: SURFACE MOUNT SHIELD

DRAWN BY: SDH
DATE: 2015-11-13
APPROVED BY: ND
DATE: 2015-11-20

FRS: SDH
MATERIAL: MATTE
SCALE: 2:1
CAGE CODE: 4J674
SHEET: 1 OF 2

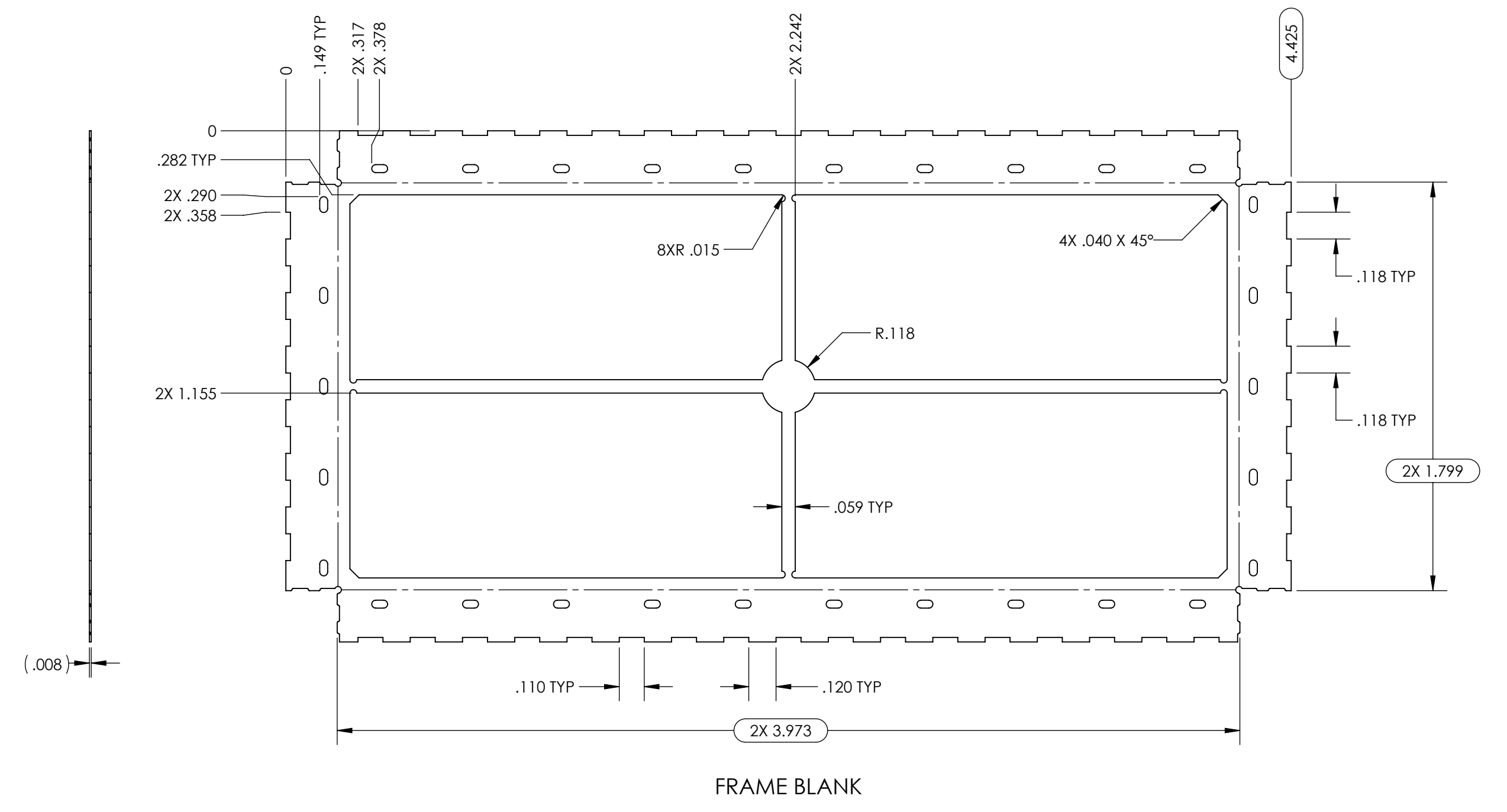
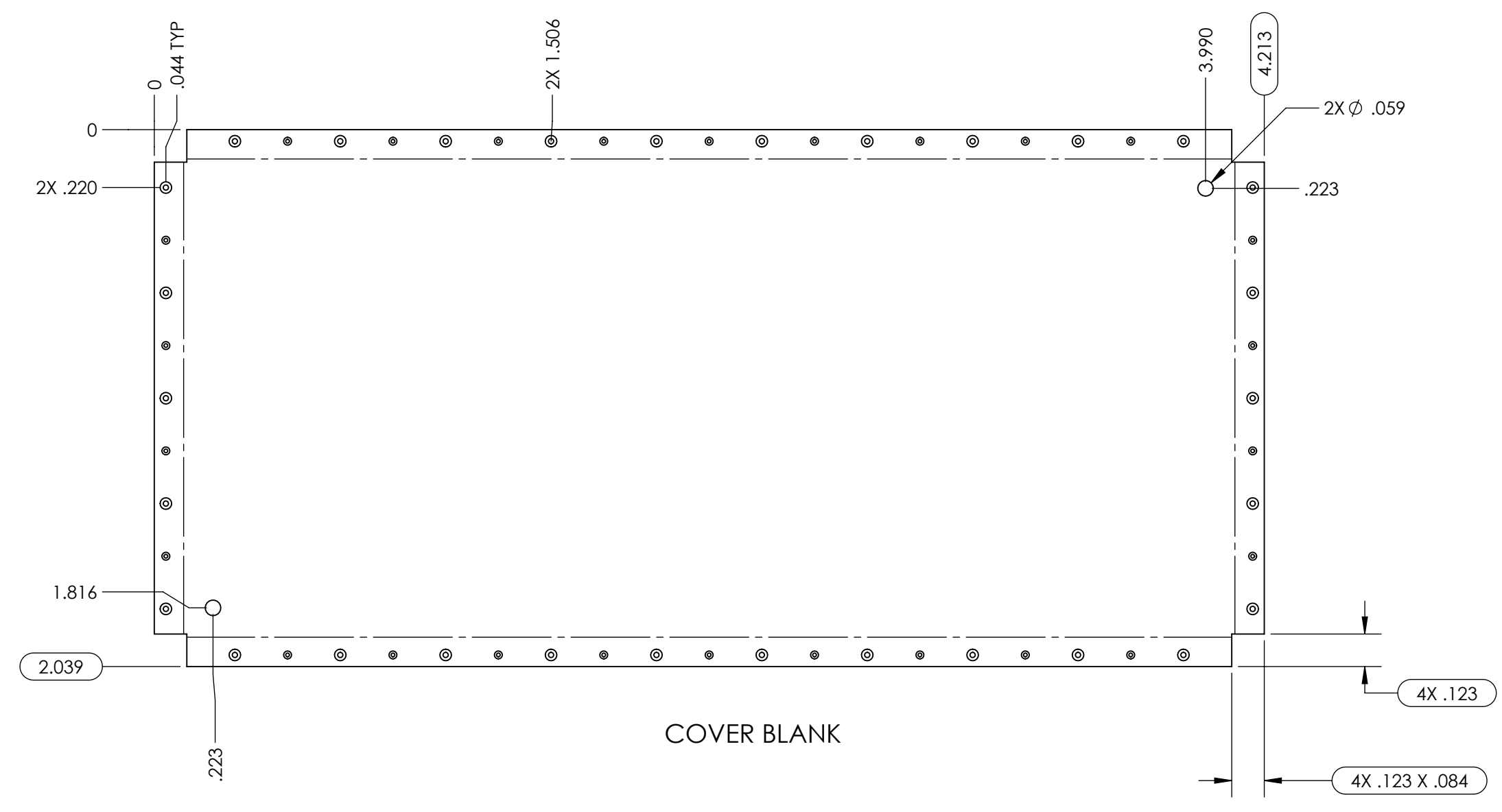

THIS DOCUMENT CONTAINS PROPRIETARY INFORMATION OWNED BY LEADERTECH, OR DEVELOPED AT ITS OWN PRIVATE EXPENSE, AND MAY NOT BE USED, DUPLICATED, OR DISCLOSED IN WHOLE OR IN PART FOR ANY PURPOSE INCLUDING DESIGN, MANUFACTURE OR PROCUREMENT WITHOUT THE WRITTEN PERMISSION OF LEADERTECH. LEADERTECH DOES NOT GUARANTEE OR WARRANT THE PERFORMANCE CHARACTERISTICS.



SIZE: D	DWG. NO.: SMS-463-MFG	REV: B1
SCALE: 2:1	CAGE CODE: 4J674	SHEET: 2 OF 2