

NOTES:
 1. ASSURE ASSEMBLY CAPABILITY BY MATCHING WITH MATING PART

REVISION		CHANGED BY	APPROVED BY
REV.	DESCRIPTION		
A1	PRODUCTION RELEASE		

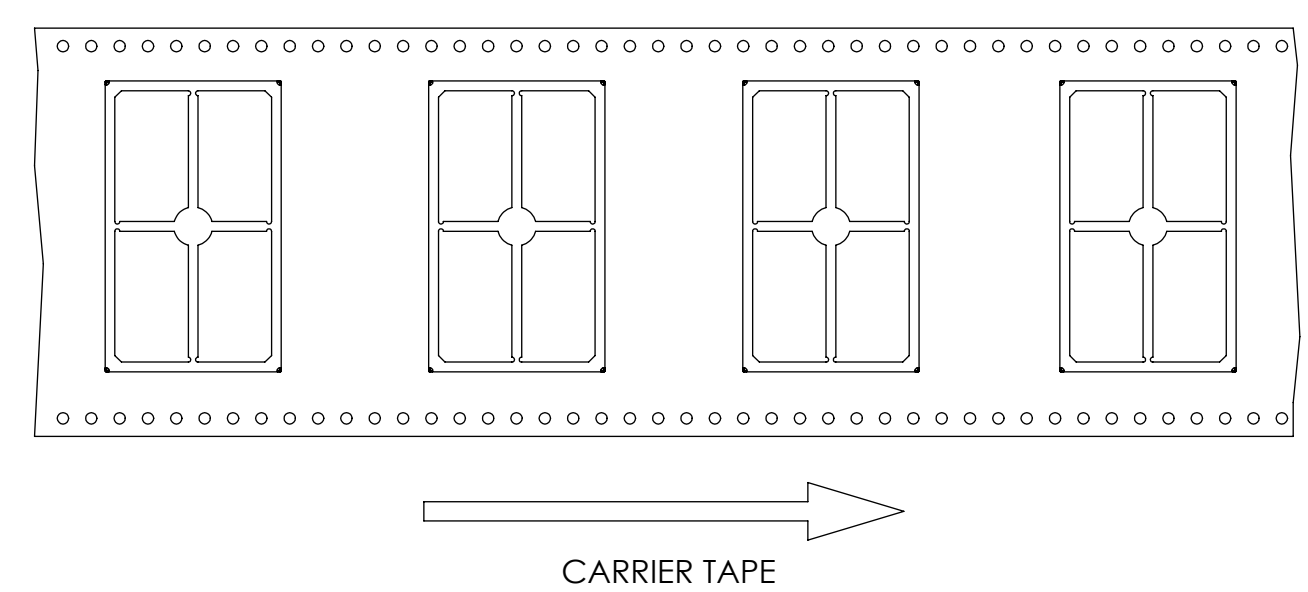
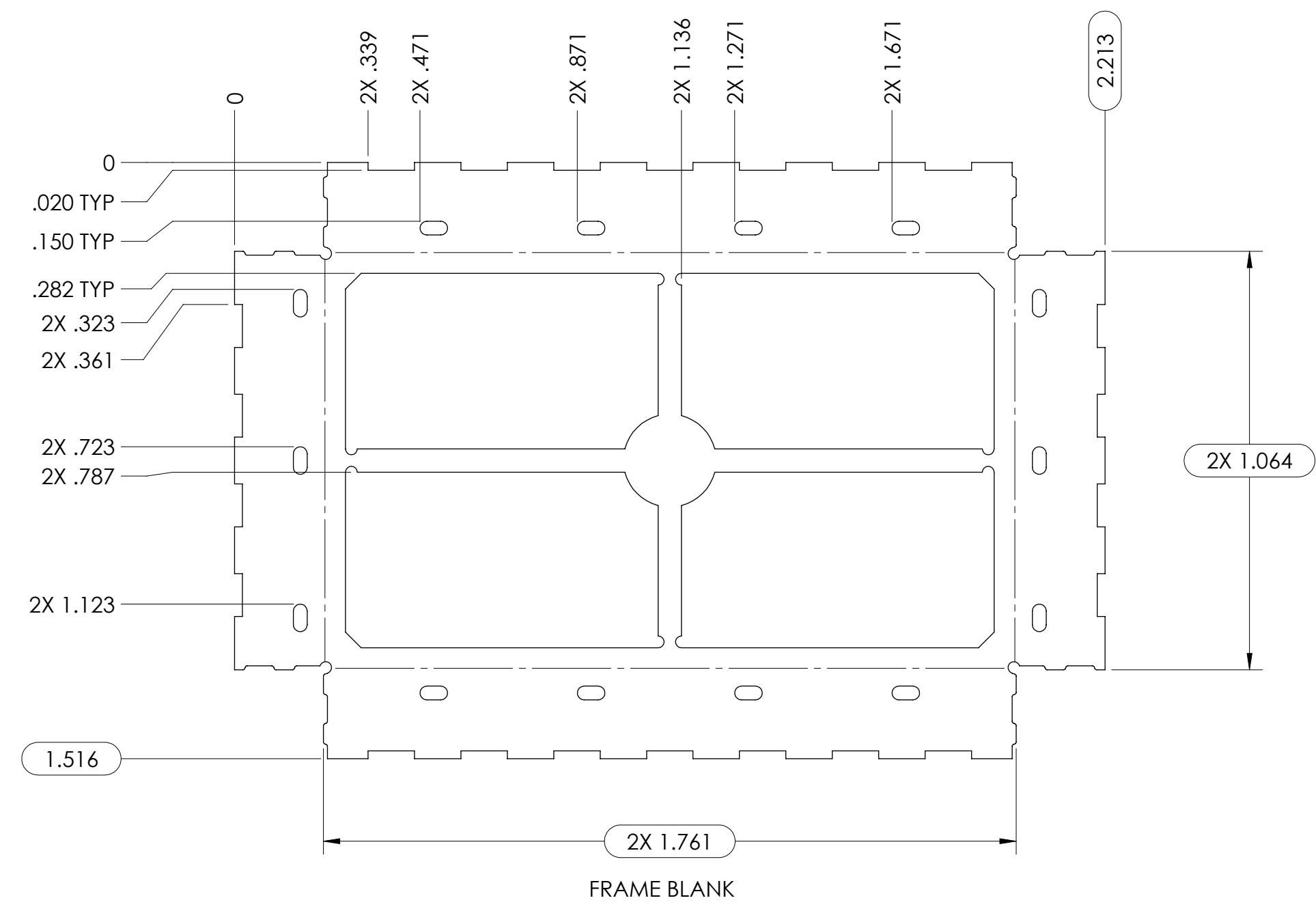
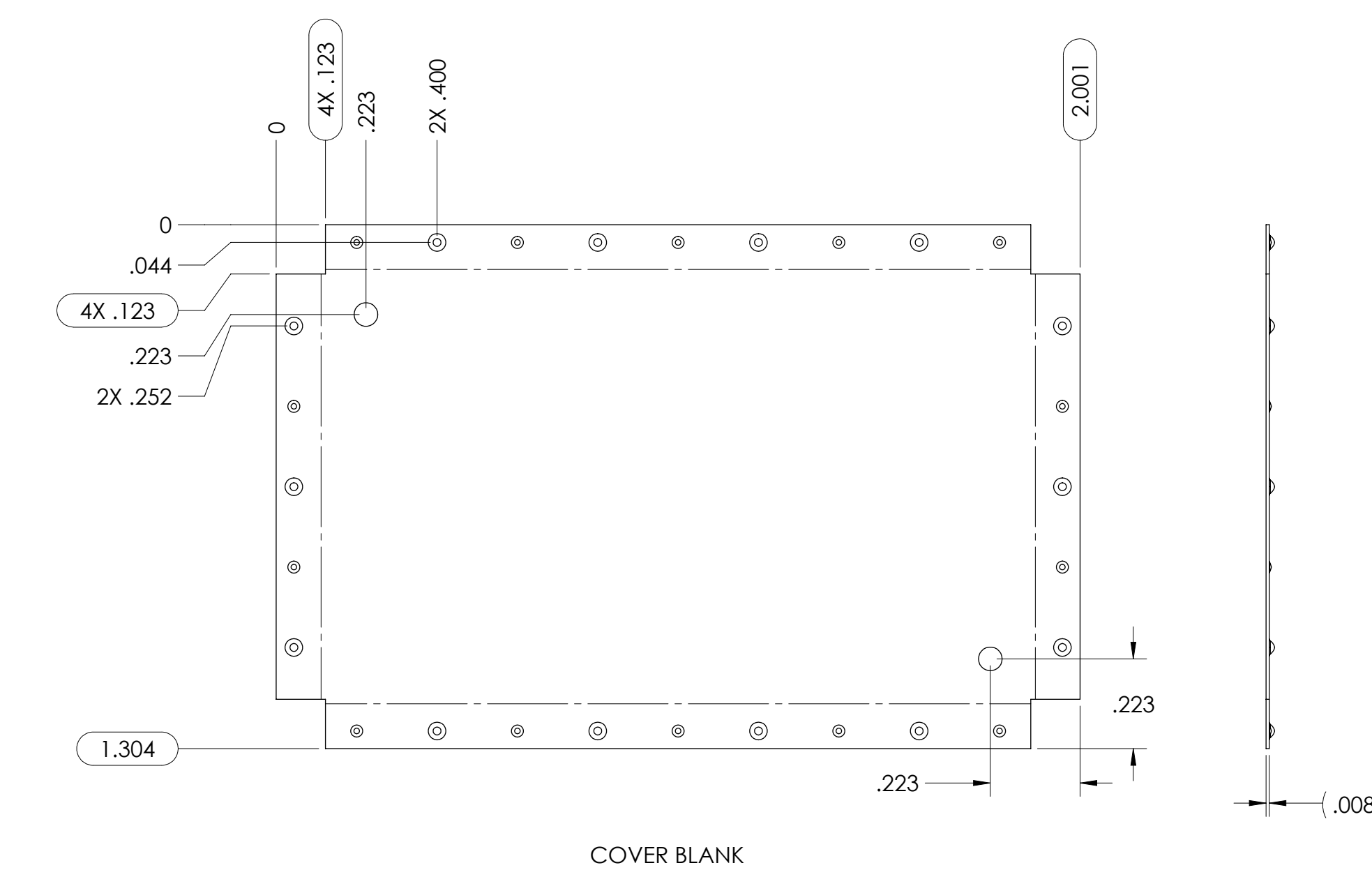
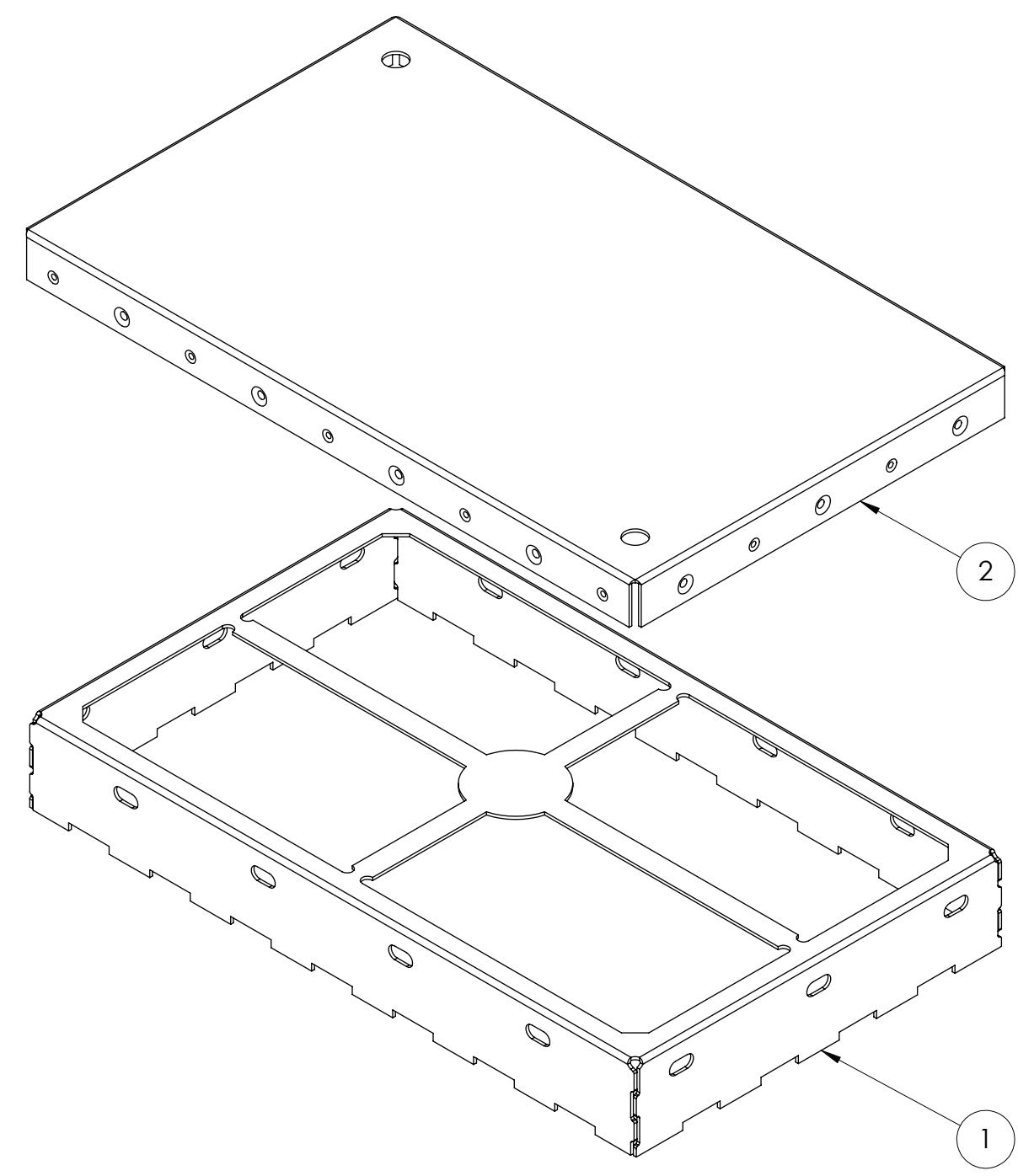
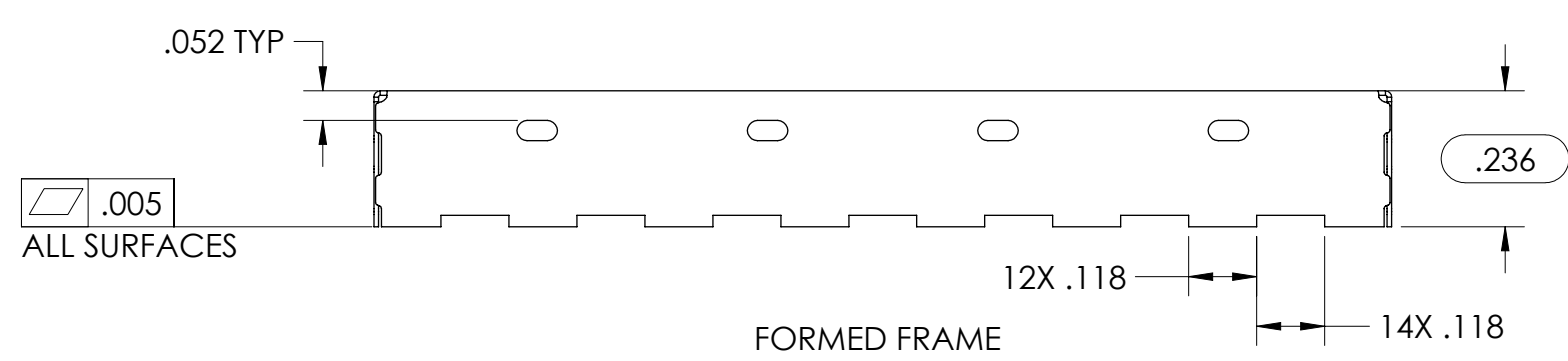
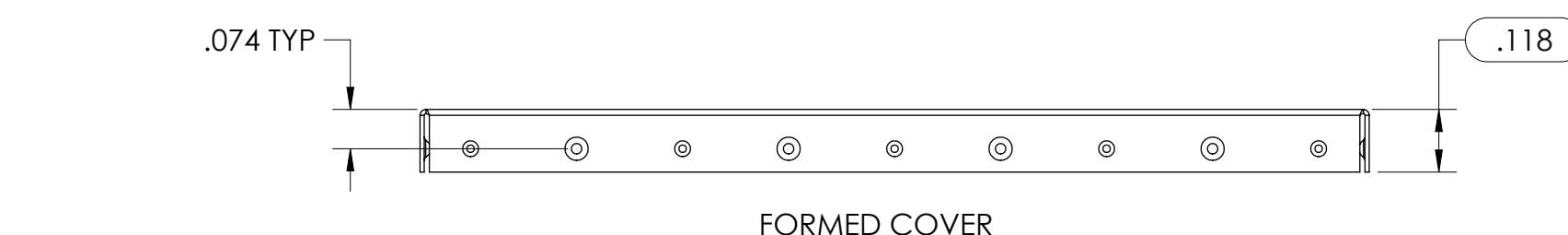
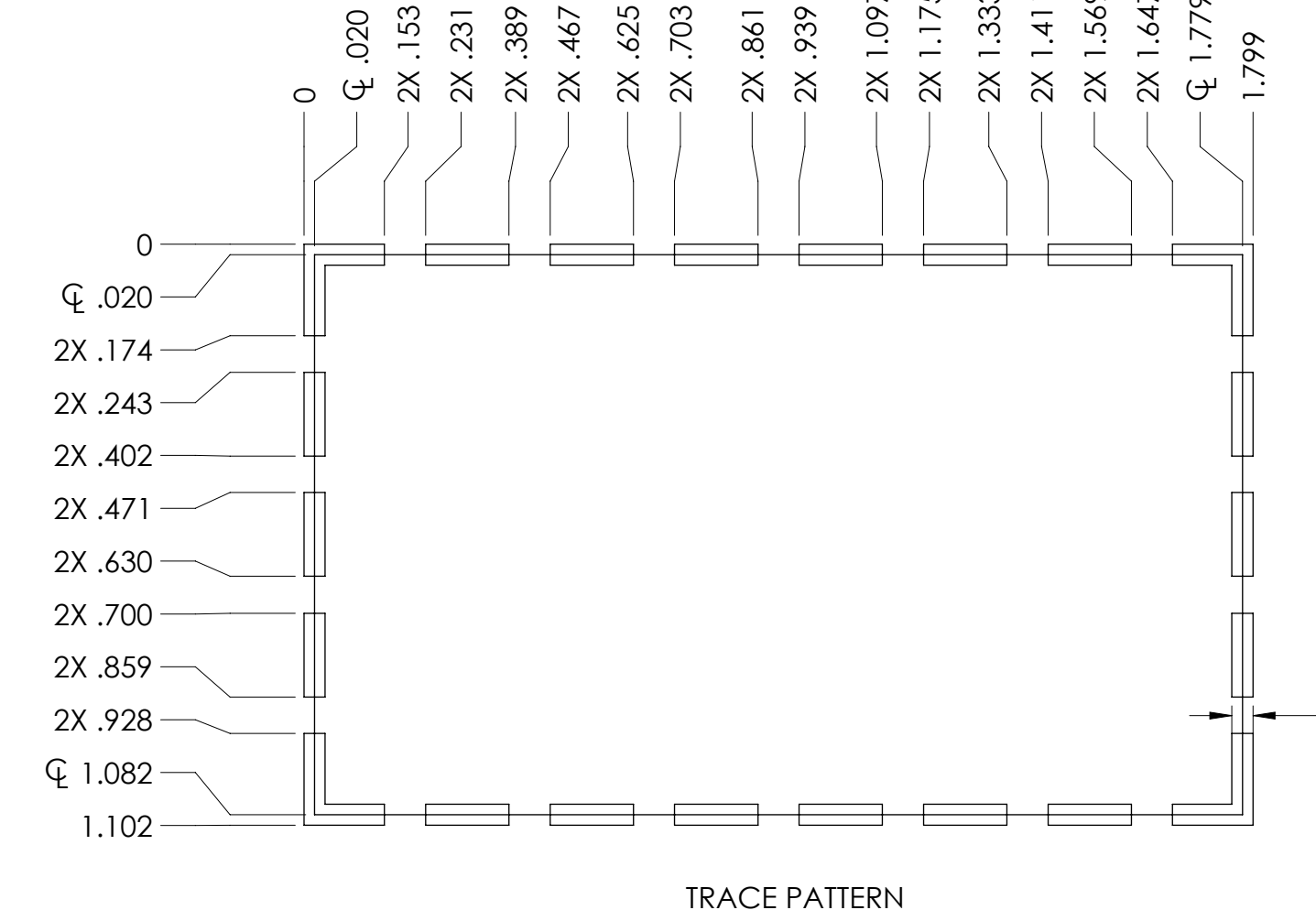
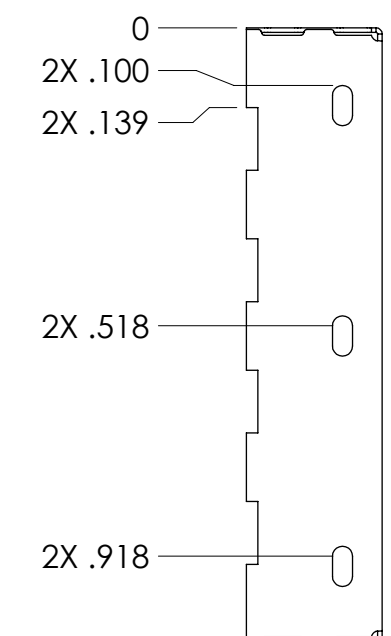
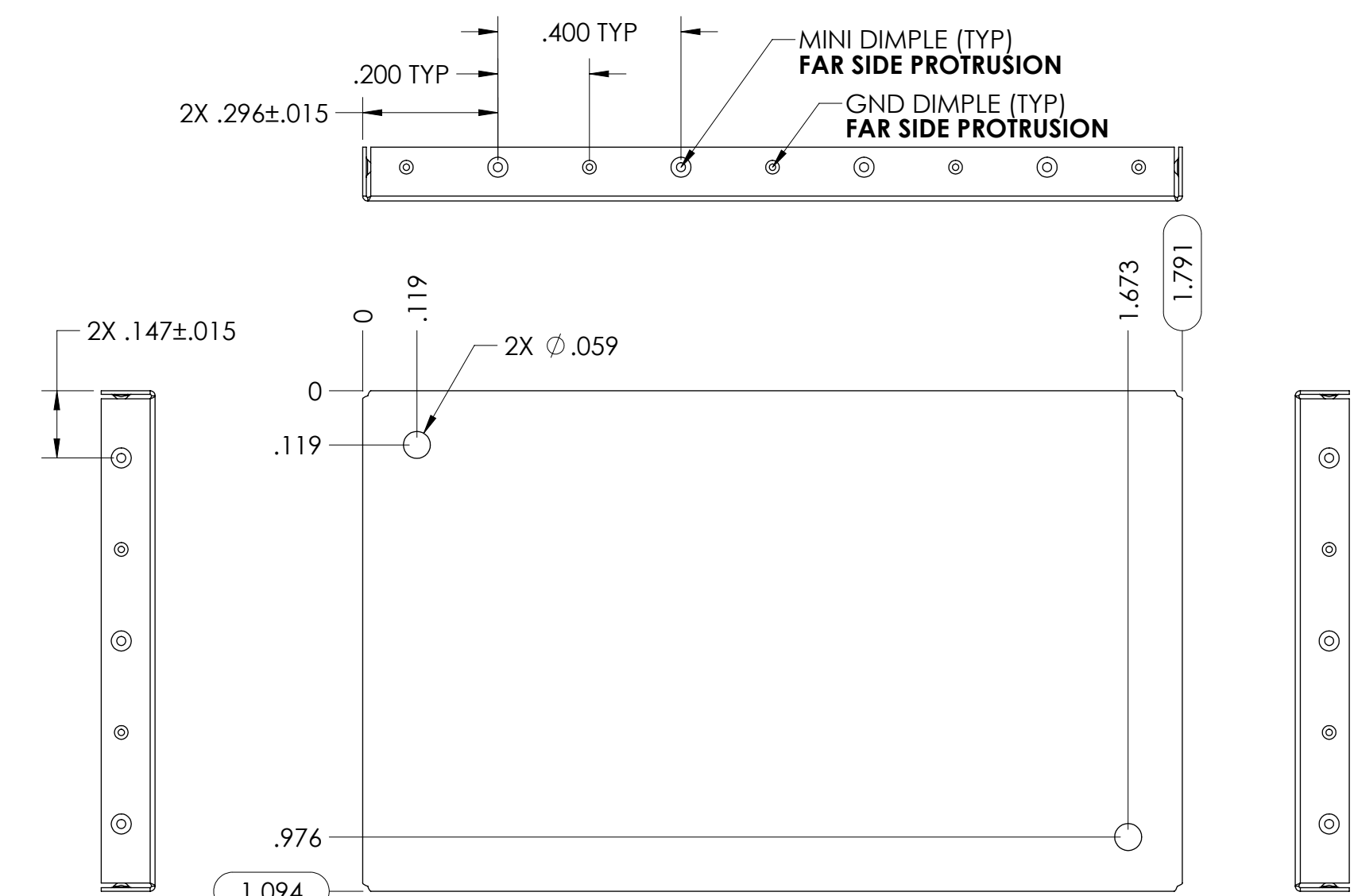

CARRIER TAPE SPECIFICATIONS						
PART NUMBER	DESCRIPTION	OVERALL DIMENSIONS	OVERALL HEIGHT	CARRIER TAPE WIDTH	CARRIER TAPE PITCH	PARTS PER REEL
SMS-460F	FRAME	1.070 X 1.767 [27.18 X 44.88]	.236 [5.99]	72 mm	40 mm	230
SMS-460C	COVER	1.094 X 1.791 [27.79 X 45.49]	.118 [3.00]	N/A	N/A	BULK PACK

ITEM NO.	PART NUMBER	DESCRIPTION	QTY.
1	SMS-460F	FRAME	1
2	SMS-460C	COVER	1

UNLESS OTHERWISE SPECIFIED:
 - ALL DIMENSIONS ARE IN INCHES
 - PART SHALL BE FREE OF BURRS AND SHARP EDGES
 - ALL DIMENSIONS SHOWN APPLY AFTER PLATINGS AND COATINGS
 - ROHS COMPLIANT PER EU DIRECTIVE 2011/65/EU
 - POI = POINT OF INTERSECTION

THIRD ANGLE PROJECTION
 ANGLES +/- 2°

FRS: JG 2015-10-30 ND 2015-11-09
 APPROVED BY:

MATERIAL: 0.008" PRE TIN STEEL

SCALE: 3:1
 CAGE CODE: 4J674
 SHEET: 1 OF 1

LEADER TECH
 a HEICO company
 The Leading Edge in PAM Manufacturing Technology

TITLE: SURFACE MOUNT SHIELD

THIS DOCUMENT CONTAINS PROPRIETARY INFORMATION OWNED BY LEADERTECH OR DEVELOPED AT ITS OWN PRIVATE EXPENSE AND MAY NOT BE REPRODUCED, COPIED, OR DISCLOSED IN WHOLE OR IN PART FOR ANY PURPOSE INCLUDING DESIGN, MANUFACTURE OR PROCUREMENT WITHOUT THE WRITTEN PERMISSION OF LEADERTECH. LEADERTECH DOES NOT GUARANTEE OR WARRANT THE PERFORMANCE CHARACTERISTICS.