

NOTES:  
 1. ASSURE ASSEMBLY CAPABILITY BY MATCHING WITH MATING PART

REVISIONS			
REV.	DESCRIPTION	CHANGED BY	APPROVED BY
A1	PRODUCTION RELEASE	-	-

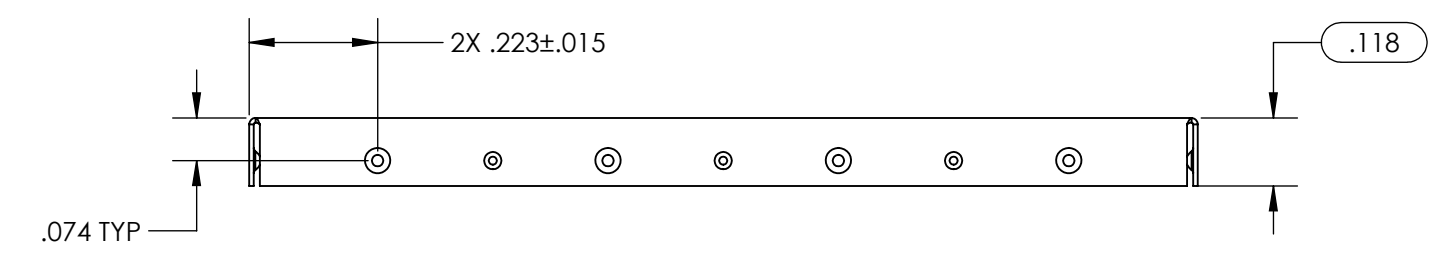

FORMED COVER

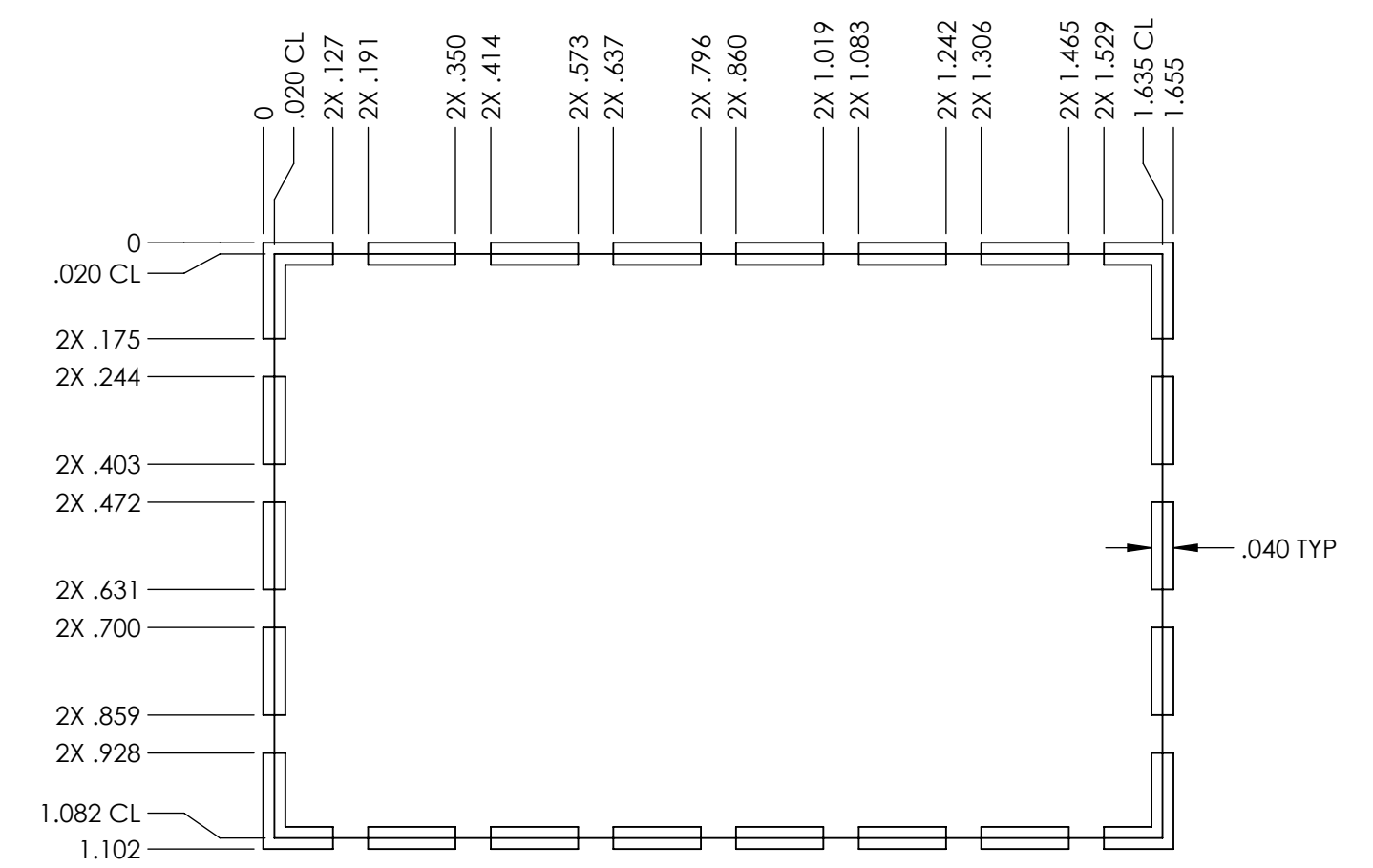
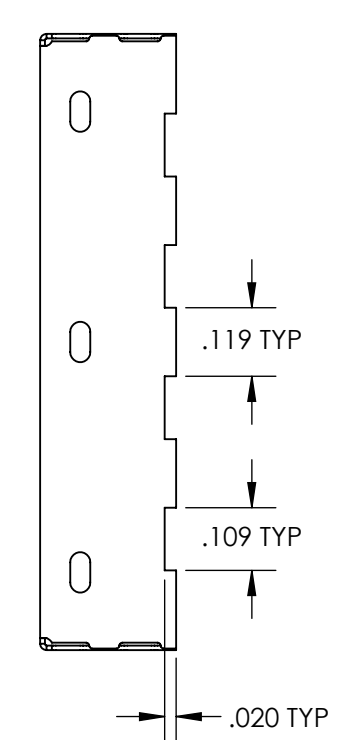
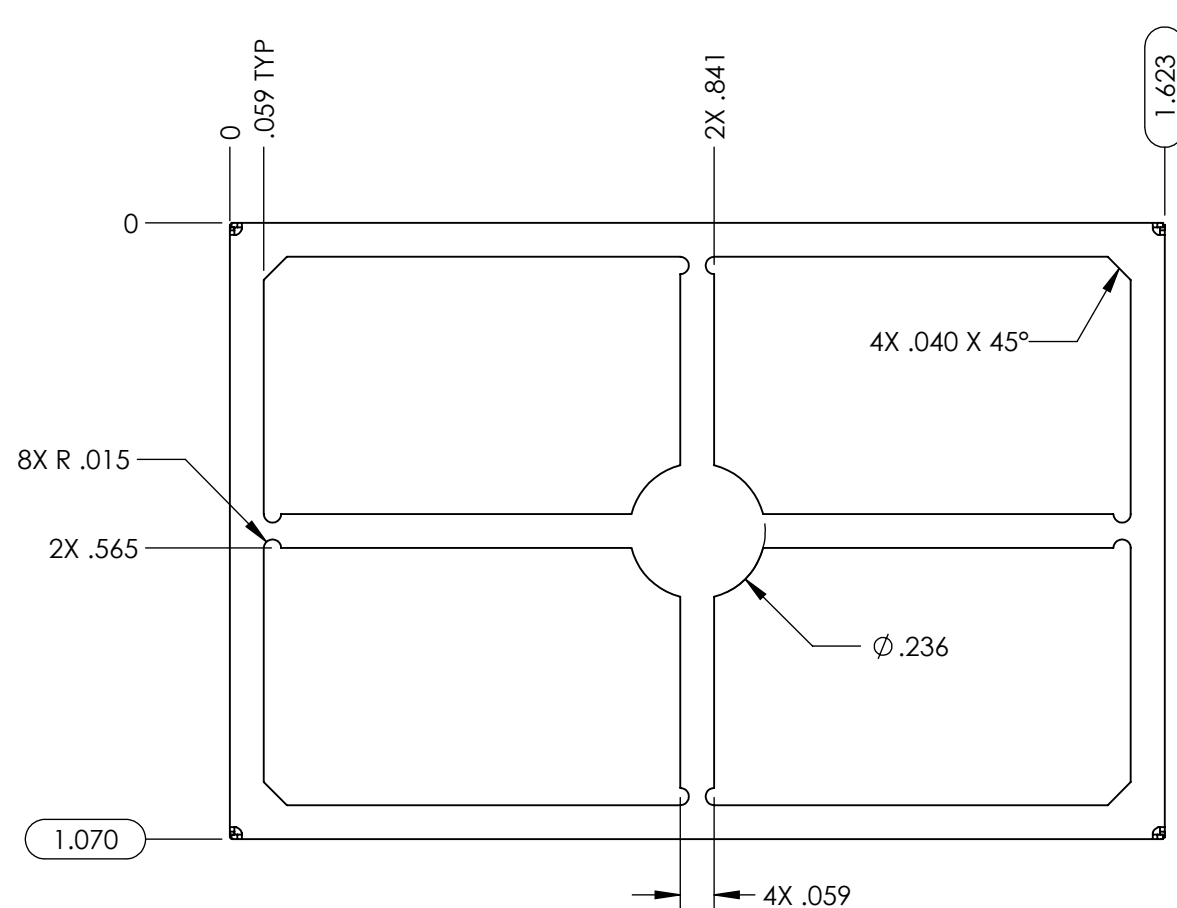
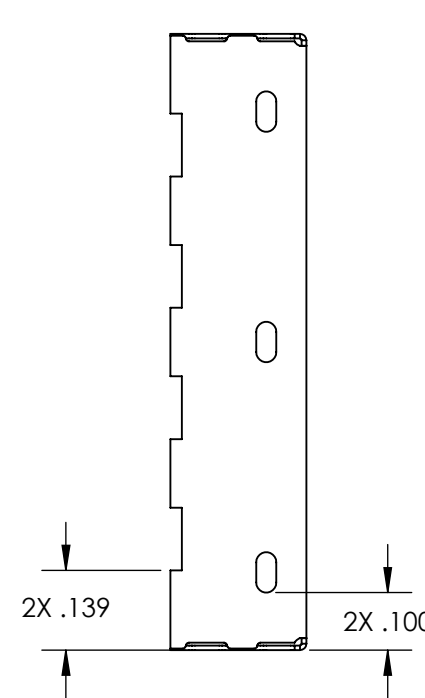
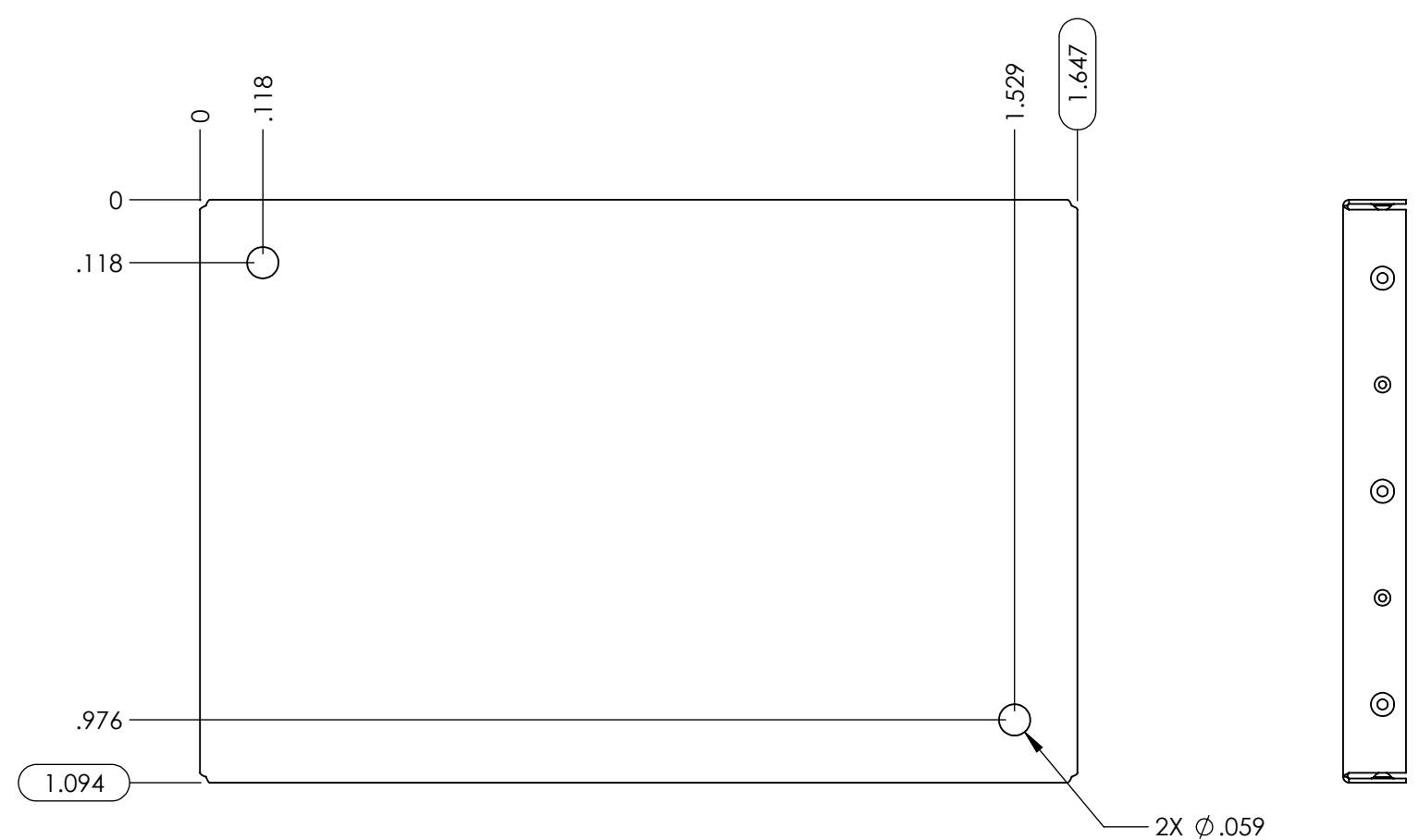
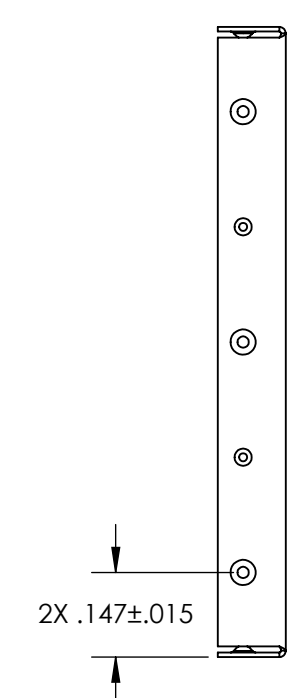
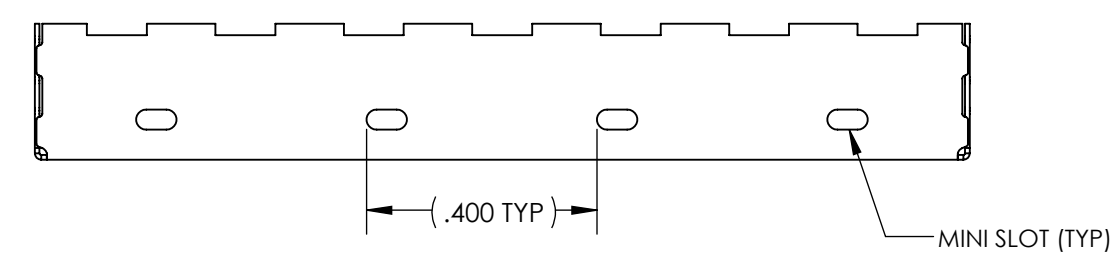
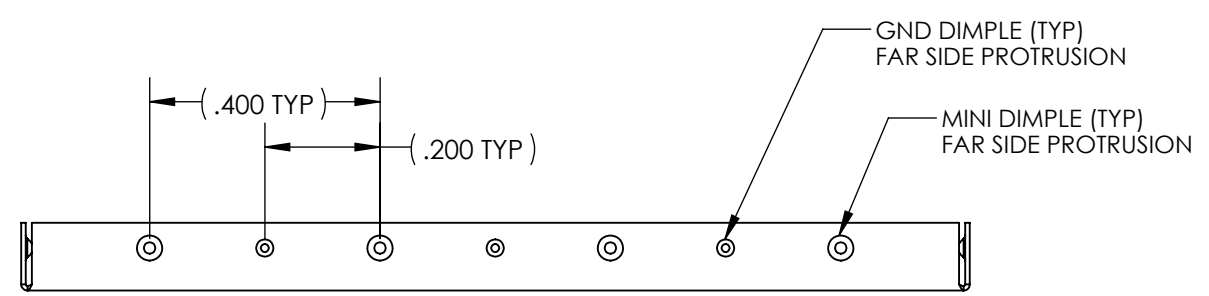
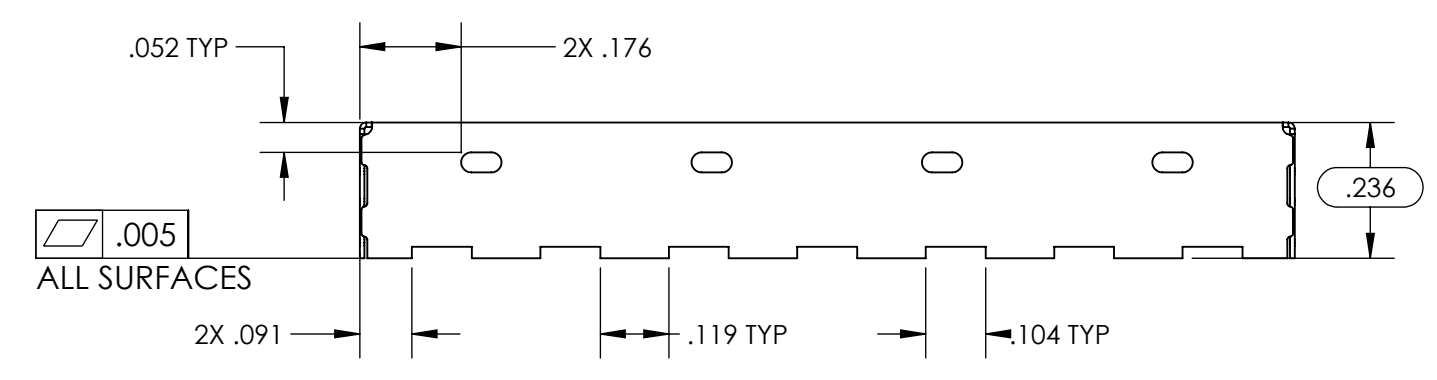

FORMED FRAME

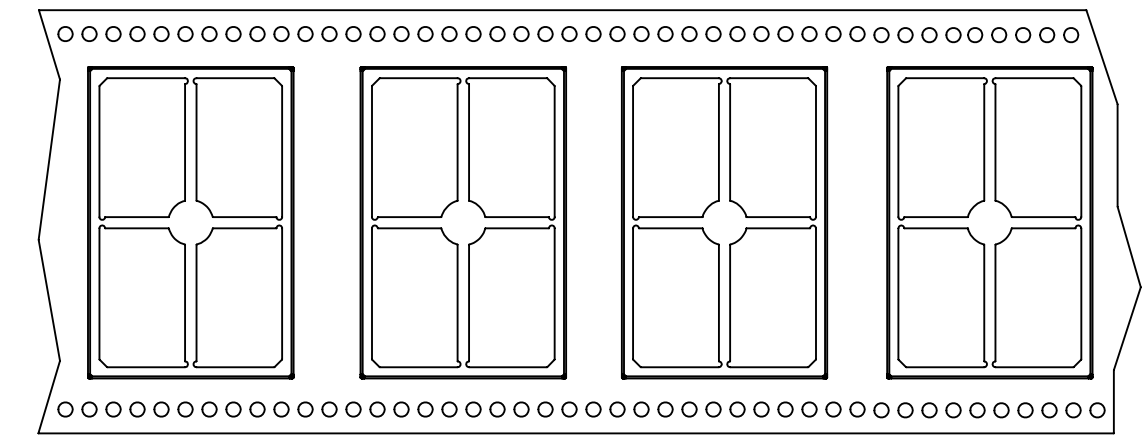

CARRIER TAPE

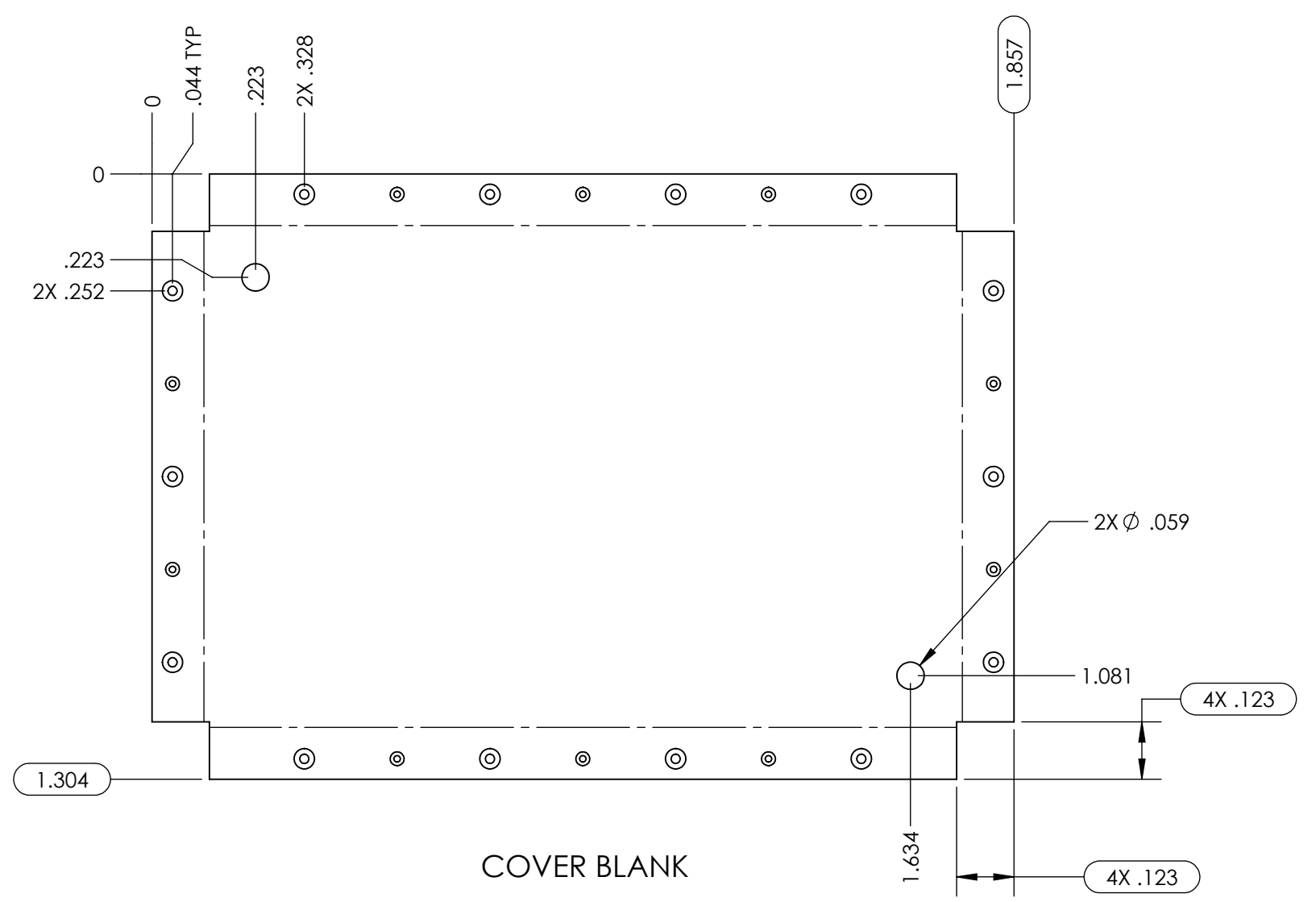

COVER BLANK

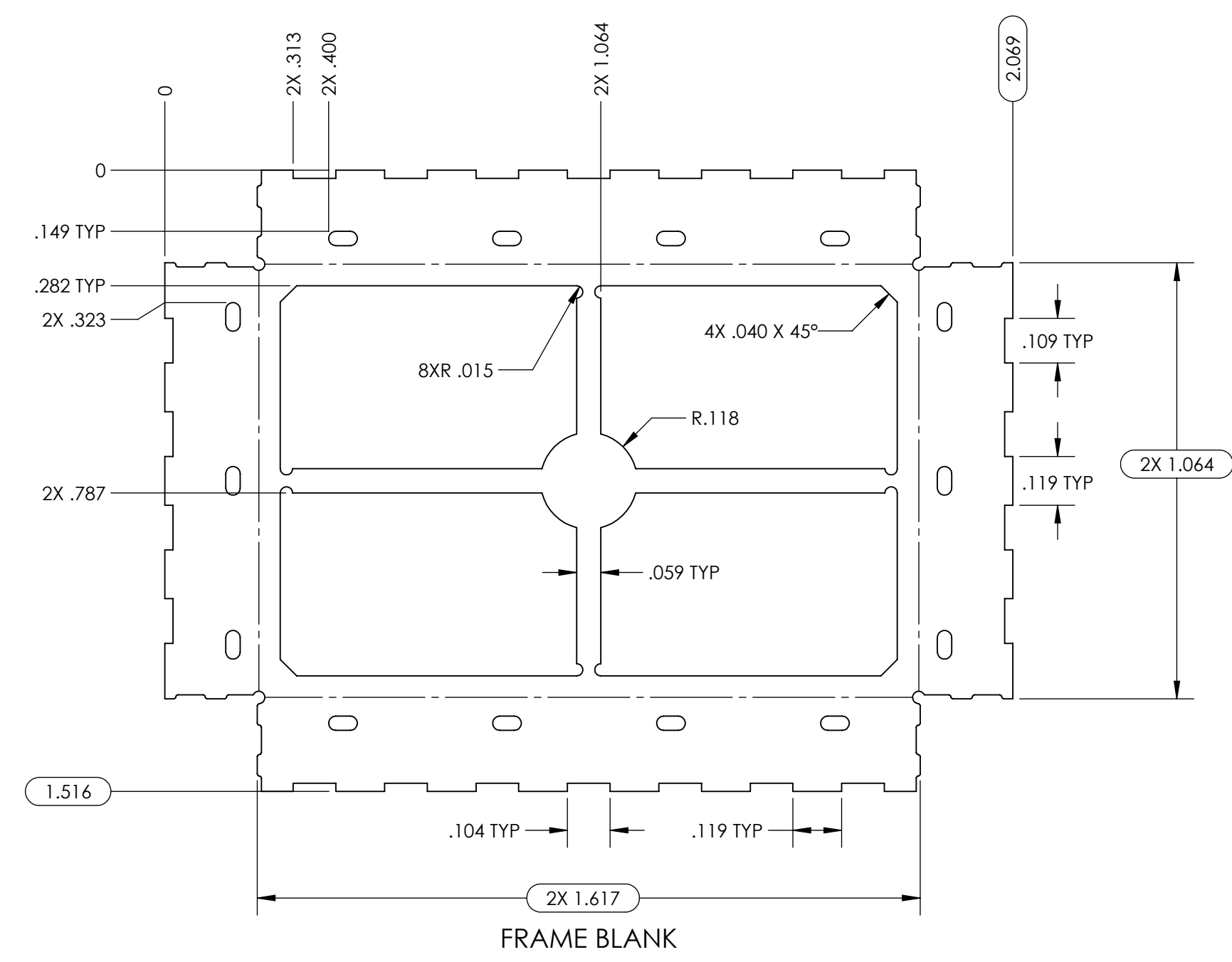

FRAME BLANK

CARRIER TAPE SPECIFICATIONS						
PART NUMBER	DESCRIPTION	OVERALL DIMENSIONS	OVERALL HEIGHT	CARRIER TAPE WIDTH	CARRIER TAPE PITCH	PARTS PER REEL
SMS-459F	FRAME	1.070 X 1.623 [27.18 X 41.22]	.236 [5.99]	56 mm	36 mm	230
SMS-459C	COVER	1.094 X 1.647 [27.79 X 41.83]	.118 [3.00]	N/A	N/A	BULK PACK

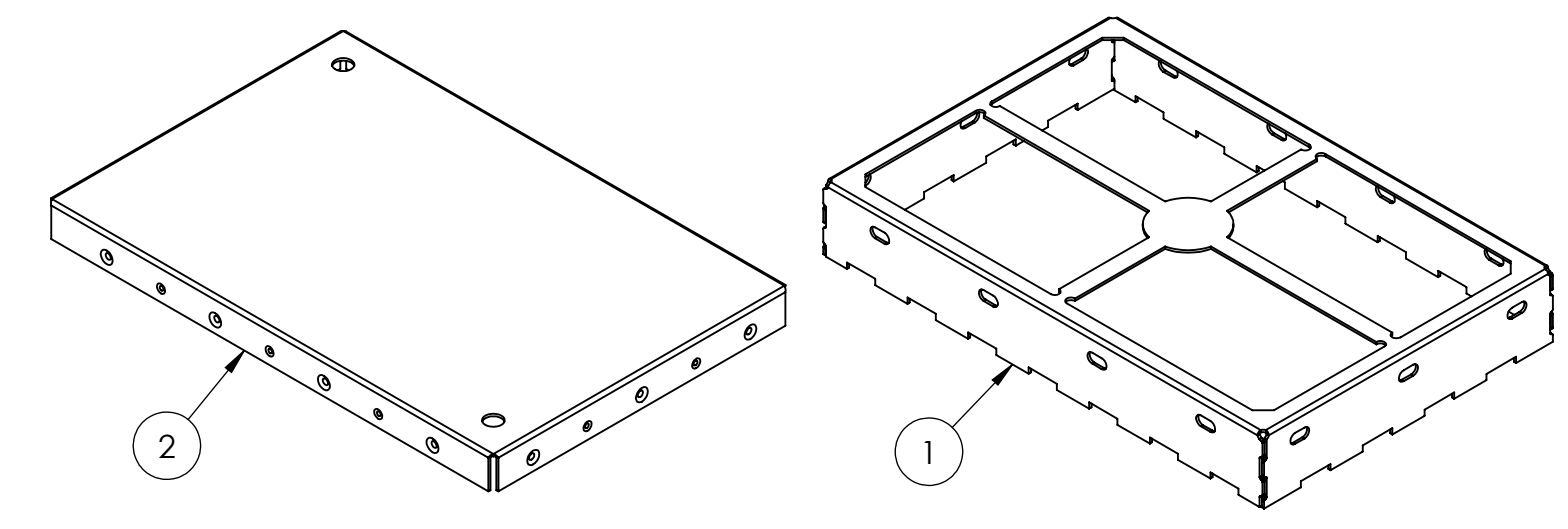

ITEM NO.	PART NUMBER	DESCRIPTION	QTY.
1	SMS-459F	FRAME	1
2	SMS-459C	COVER	1

UNLESS OTHERWISE SPECIFIED:  
 - ALL DIMENSIONS ARE IN INCHES  
 - PART SHALL BE FREE OF BURRS AND SHARP EDGES  
 - ALL DIMENSIONS SHOWN APPLY AFTER PLATING AND COATINGS  
 - ROHS COMPLIANT PER EU DIRECTIVE 2011/65/EU  
 - POI = POINT OF INTERSECTION

THIRD ANGLE PROJECTION

ANGLES +/- 2°

DRAWN BY: SDH  
 2015-11-02

APPROVED BY:

MATERIAL: MATTE  
 .008" PRE TIN STEEL

SCALE: 3:1  
 CAGE CODE: 4J674  
 SHEET: 1 OF 1

LEADER TECH  
 a HEICO company  
 The Leading Edge in PAM Manufacturing Technology

TITLE: SURFACE MOUNT SHIELD

THIS DOCUMENT CONTAINS PROPRIETARY INFORMATION OWNED BY LEADERTECH OR DEVELOPED AT ITS OWN PRIVATE EXPENSE AND MAY NOT BE USED, DUPLICATED OR DISCLOSED IN WHOLE OR IN PART FOR ANY PURPOSE INCLUDING DESIGN, MANUFACTURE OR PROCUREMENT WITHOUT THE WRITTEN PERMISSION OF LEADERTECH. LEADERTECH DOES NOT GUARANTEE OR WARRANT THE PERFORMANCE CHARACTERISTICS.