

NOTES:
 1. ASSURE ASSEMBLY CAPABILITY BY MATCHING WITH MATING PART

REVISION		CHANGED BY	APPROVED BY
REV.	DESCRIPTION		
A1	PRODUCTION RELEASE		

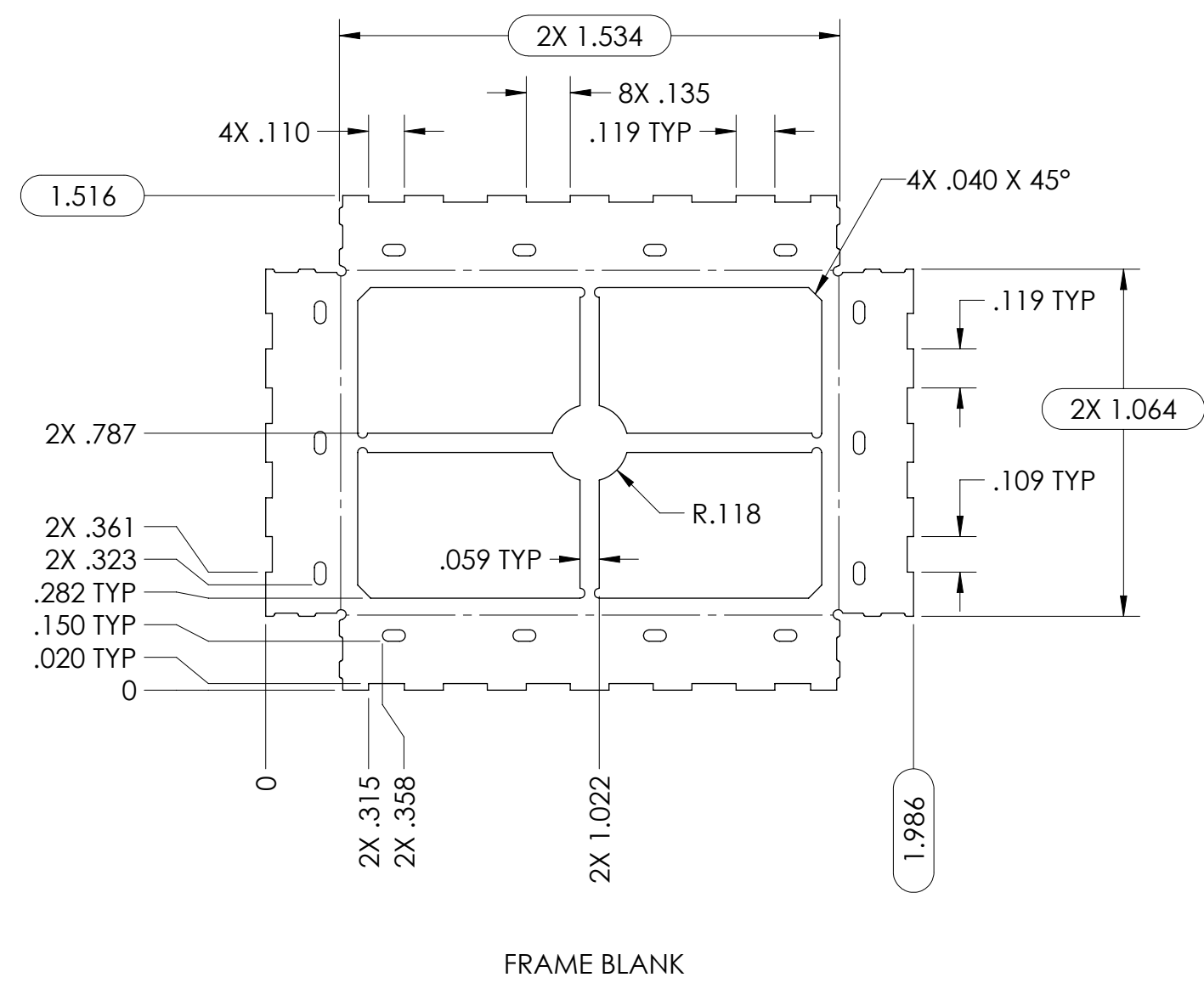

CARRIER TAPE SPECIFICATIONS						
PART NUMBER	DESCRIPTION	OVERALL DIMENSIONS	OVERALL HEIGHT	CARRIER TAPE WIDTH	CARRIER TAPE PITCH	PARTS PER REEL
SMS-458F	FRAME	1.070 X 1.540 [27.18 X 39.12]	.236 [5.99]	56 mm	40 mm	240
SMS-458C	COVER	1.094 X 1.564 [27.79 X 39.73]	.118 [3.00]	N/A	N/A	BULK PACK

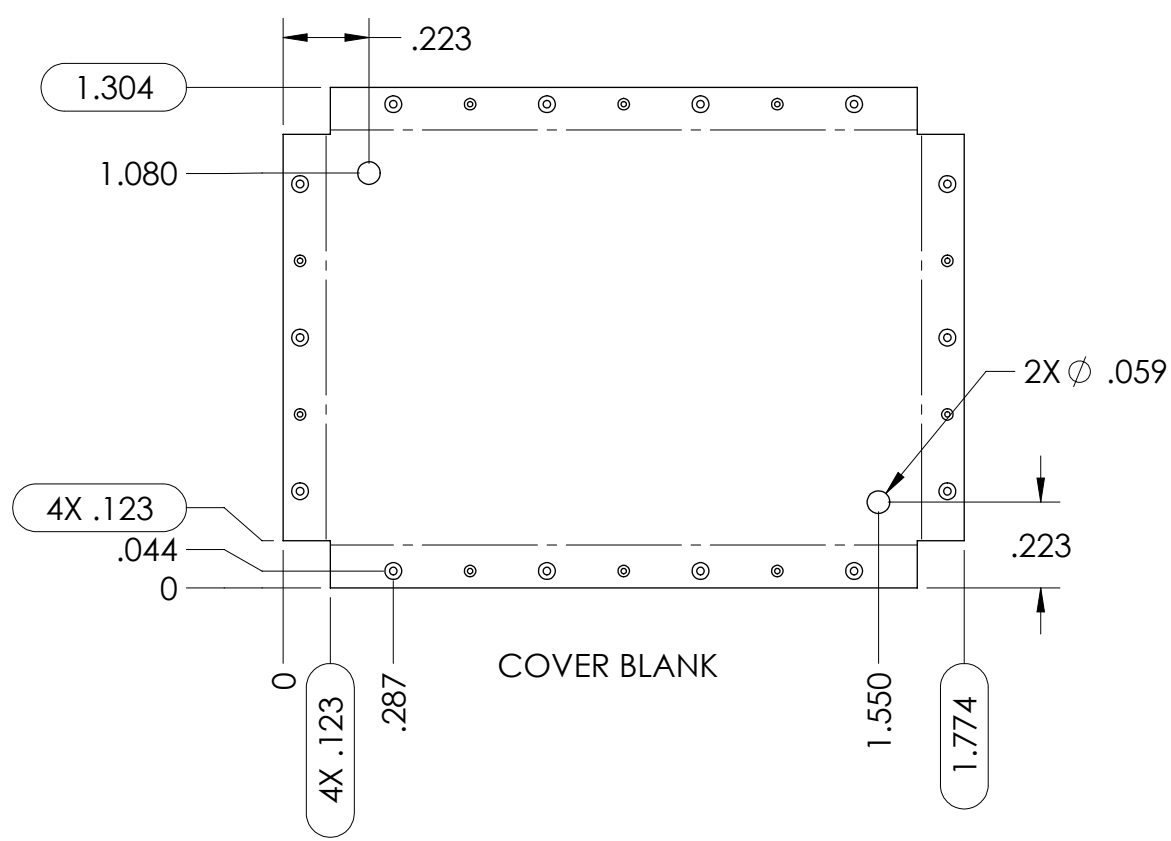
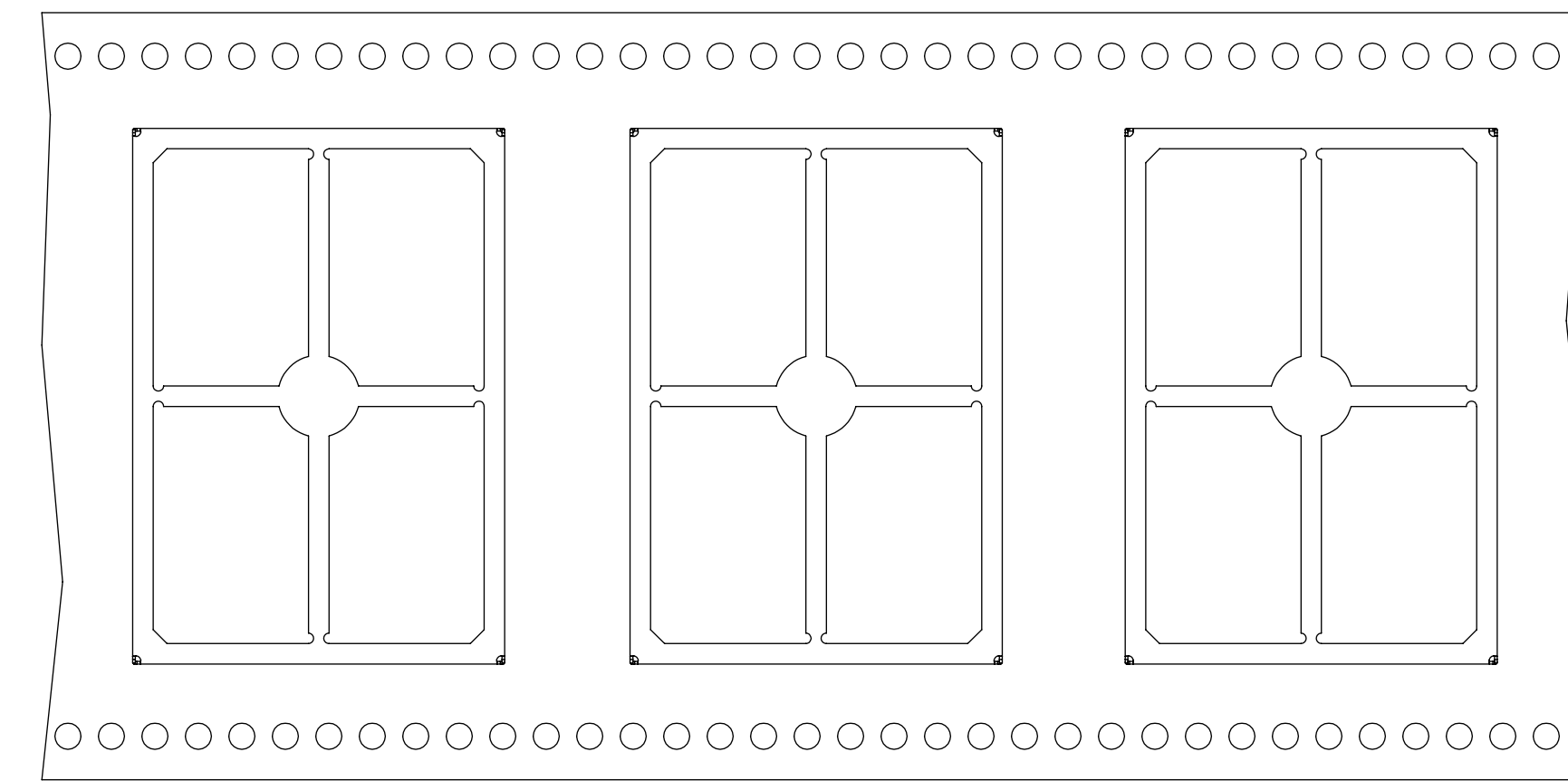
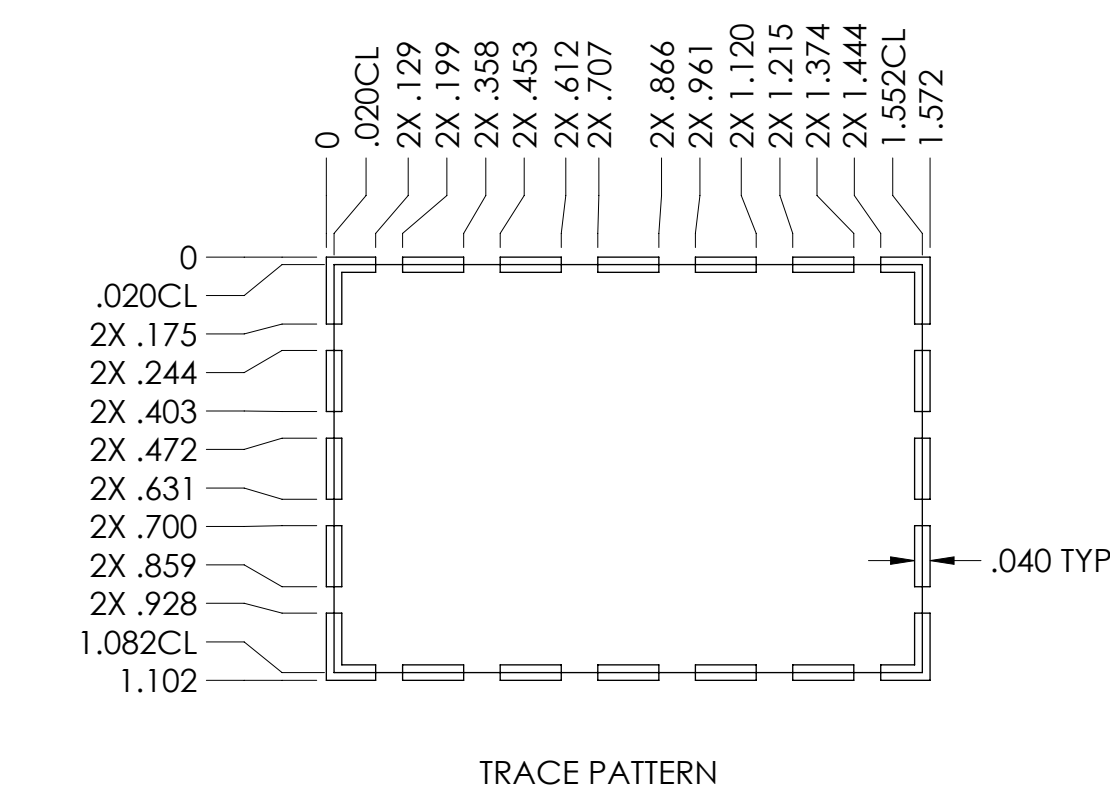
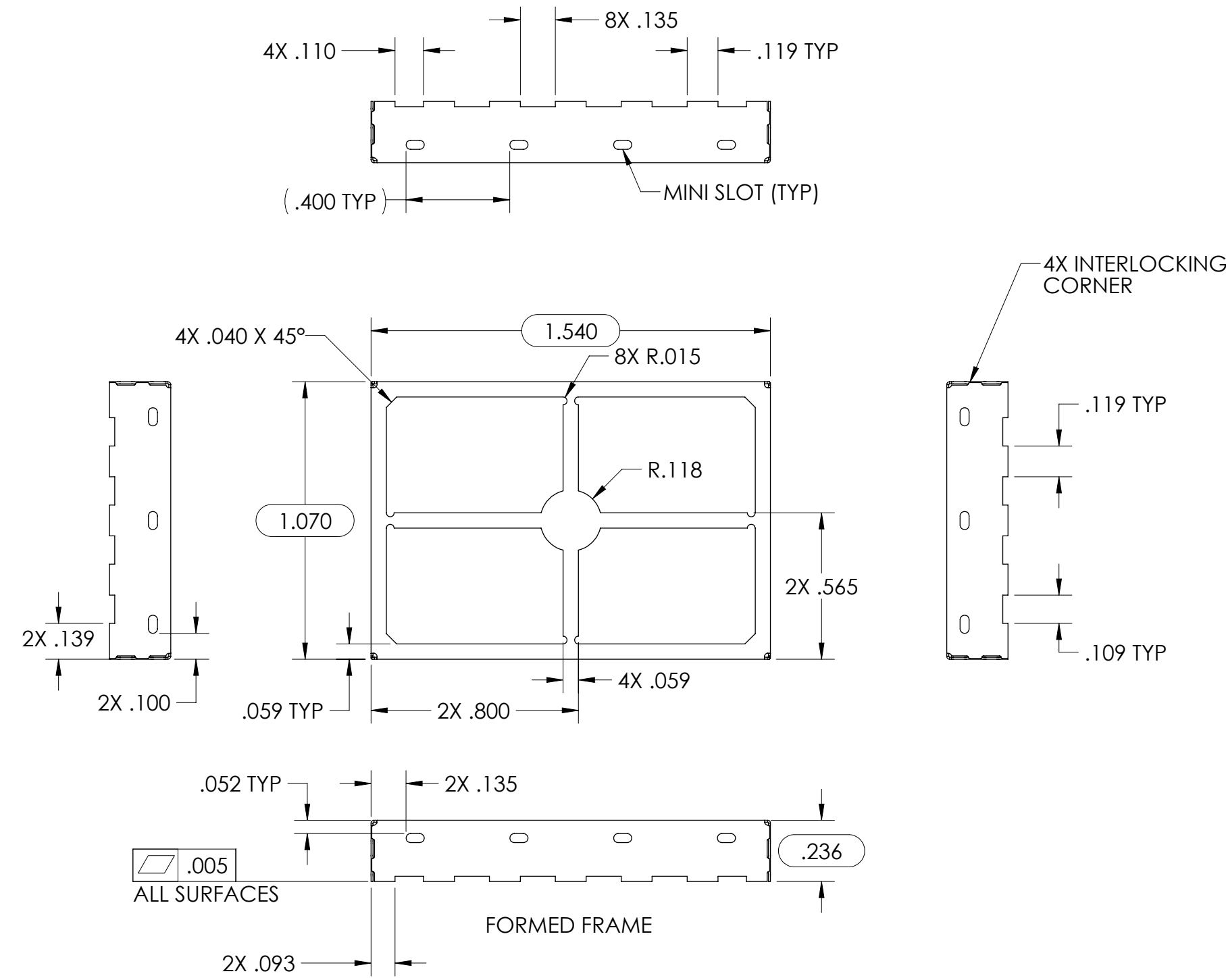
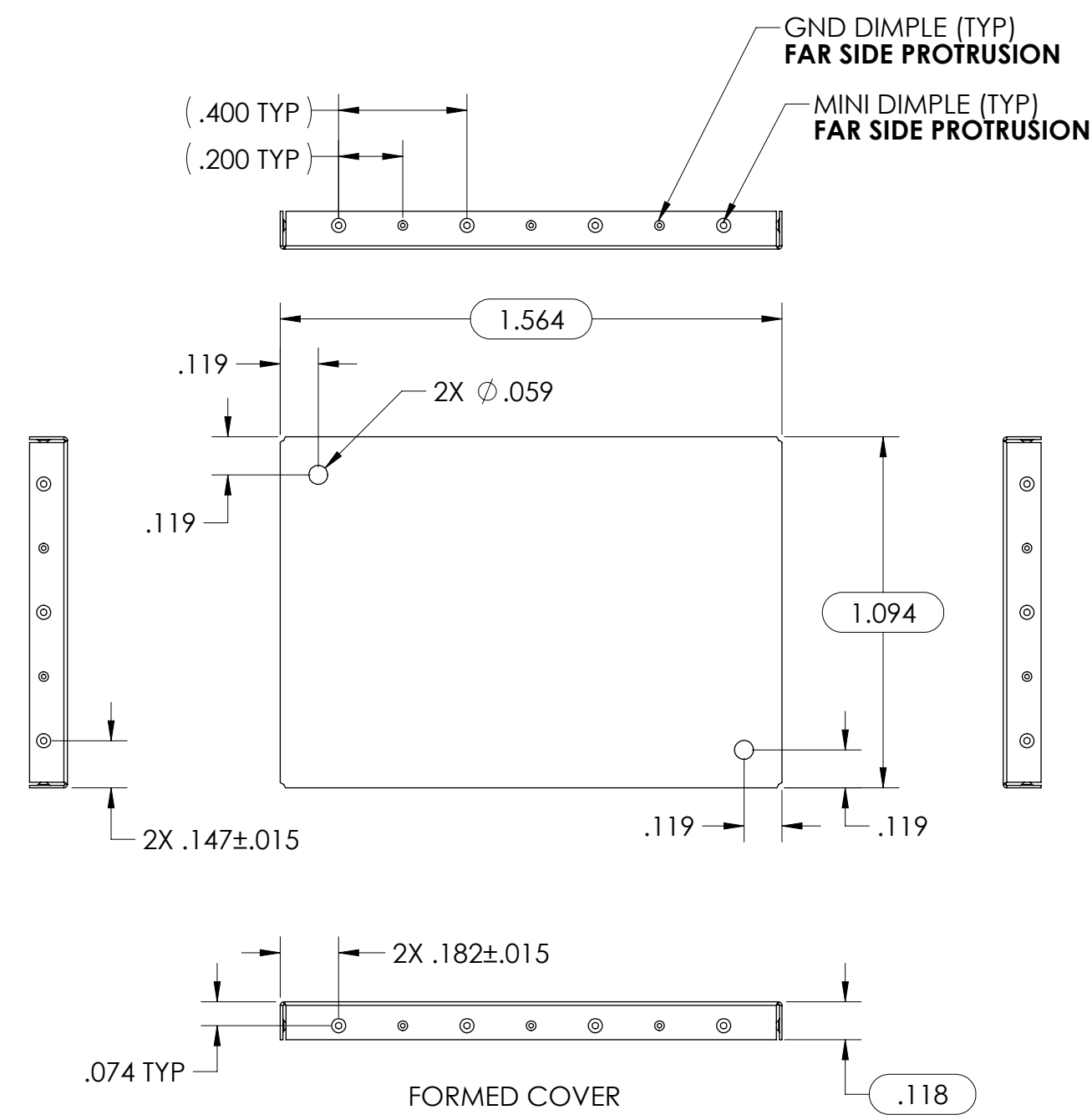
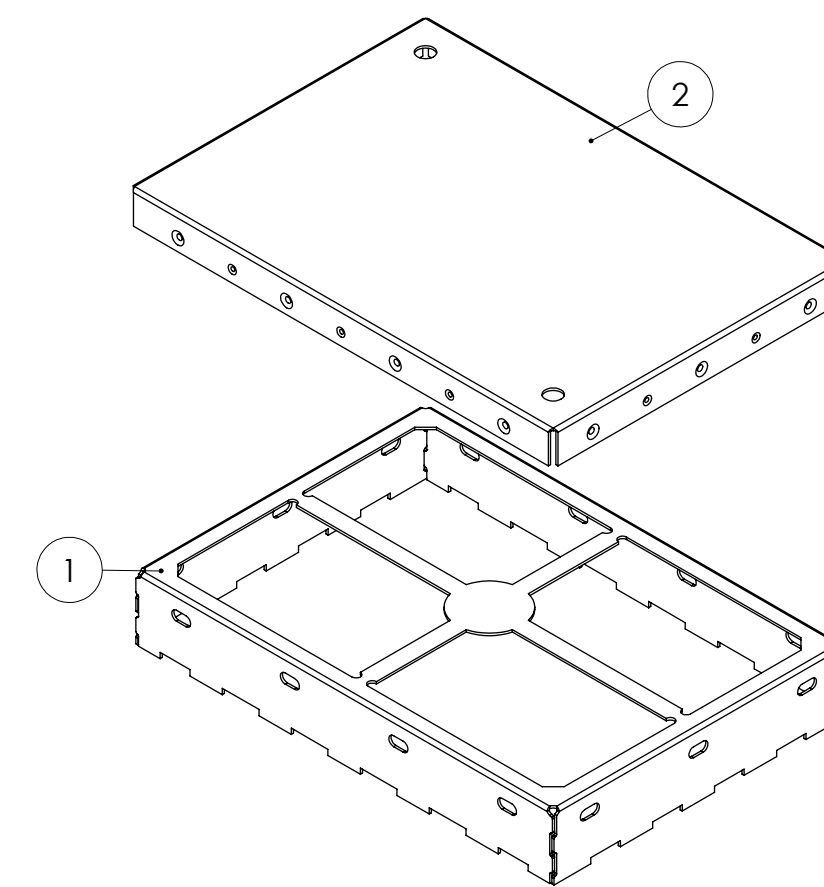
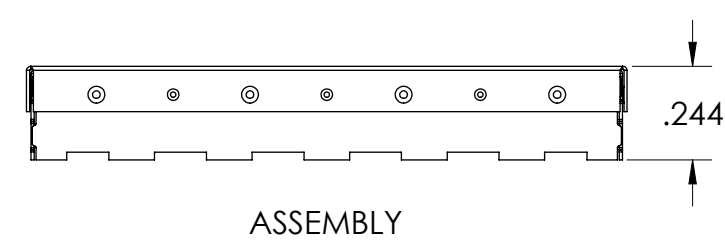

ITEM NO.	PART NUMBER	DESCRIPTION	QTY.
1	SMS-458F	FRAME	1
2	SMS-458C	COVER	1

UNLESS OTHERWISE SPECIFIED:
 - ALL DIMENSIONS ARE IN INCHES
 - PART SHALL BE FREE OF BURRS AND SHARP EDGES
 - ALL DIMENSIONS SHOWN APPLY AFTER PLATING AND COATINGS
 - ROHS COMPLIANT PER EU DIRECTIVE 2011/65/EU
 - POI = POINT OF INTERSECTION

THIRD ANGLE PROJECTION

LEADER TECH
 a HEICO company
 The Leading Edge in PAF Manufacturing Technology

TITLE: SURFACE MOUNT SHIELD

DRAWN BY: JG 2015-10-30 APPROVED BY:

MATERIAL: MATTE 0.008" PRE TIN STEEL

SCALE: 2:1 CAGE CODE: 4J674 SHEET: 1 OF 1

THIS DOCUMENT CONTAINS PROPRIETARY INFORMATION OWNED BY LEADERTECH OR DEVELOPED AT ITS OWN PRIVATE EXPENSE AND MAY NOT BE USED, REPRODUCED OR DISCLOSED IN WHOLE OR IN PART FOR ANY PURPOSE INCLUDING DESIGN, MANUFACTURE OR PROCUREMENT WITHOUT THE WRITTEN PERMISSION OF LEADERTECH. LEADERTECH DOES NOT GUARANTEE OR WARRANT THE PERFORMANCE CHARACTERISTICS.