

NOTES:
1. ASSURE ASSEMBLY CAPABILITY BY MATCHING WITH MATING PART

REVISIONS			
REV.	DESCRIPTION	CHANGED BY	APPROVED BY
A1	PRODUCTION RELEASE	-	-

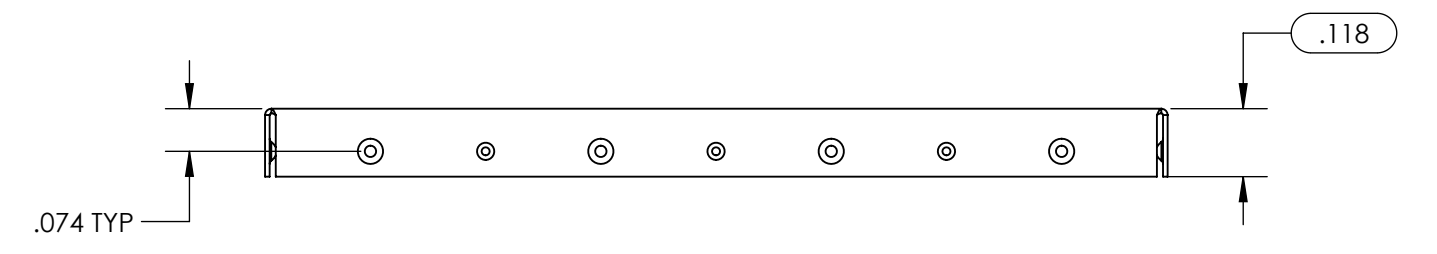

FORMED COVER

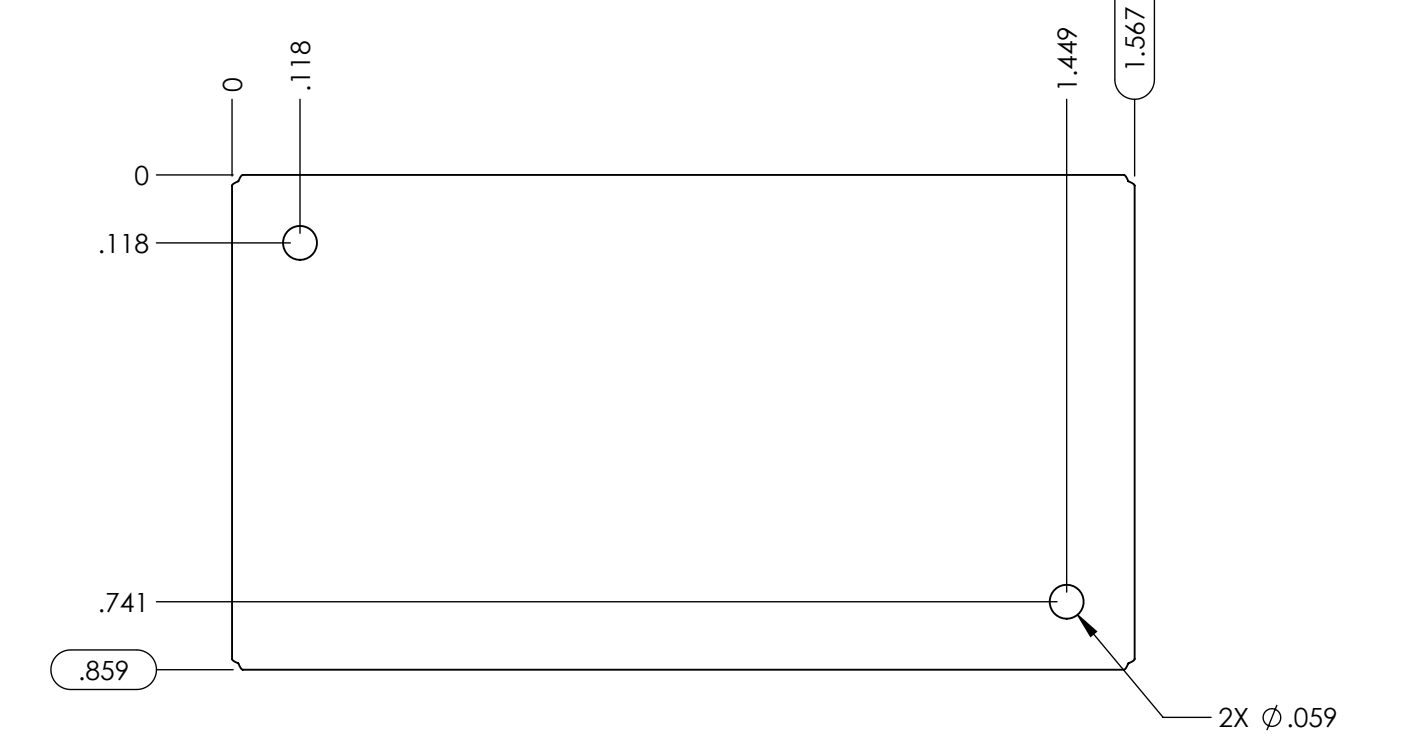
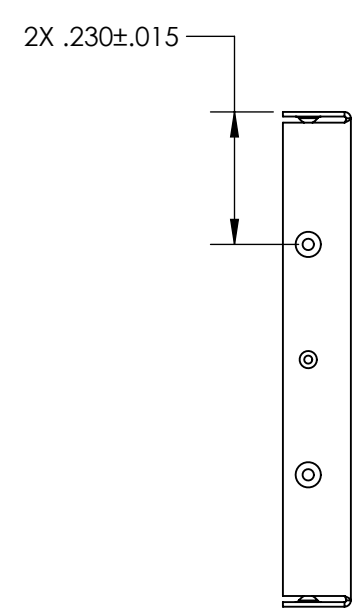
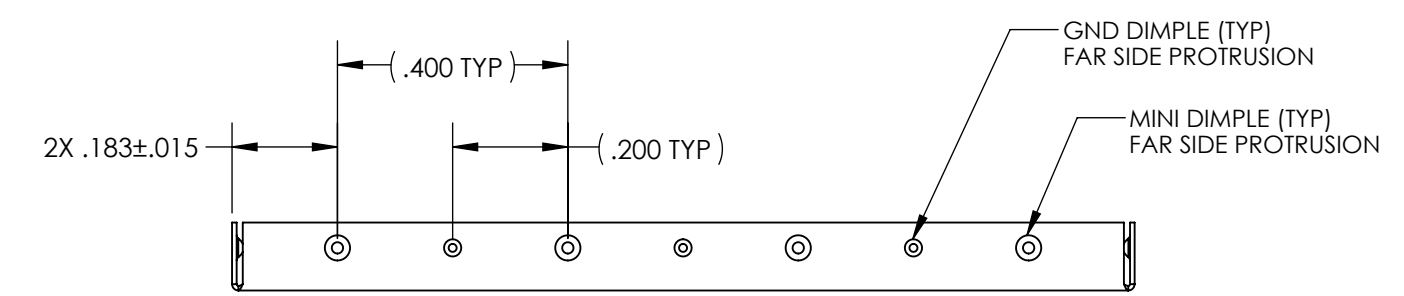
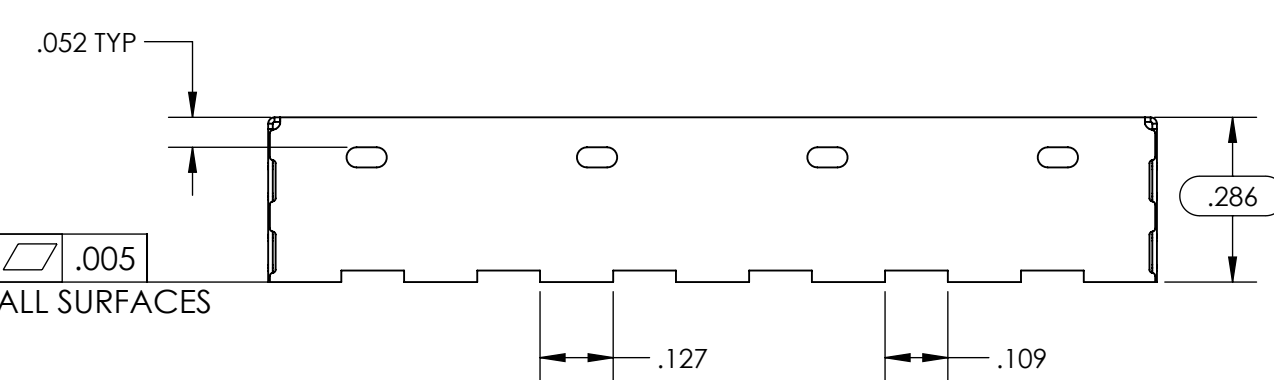
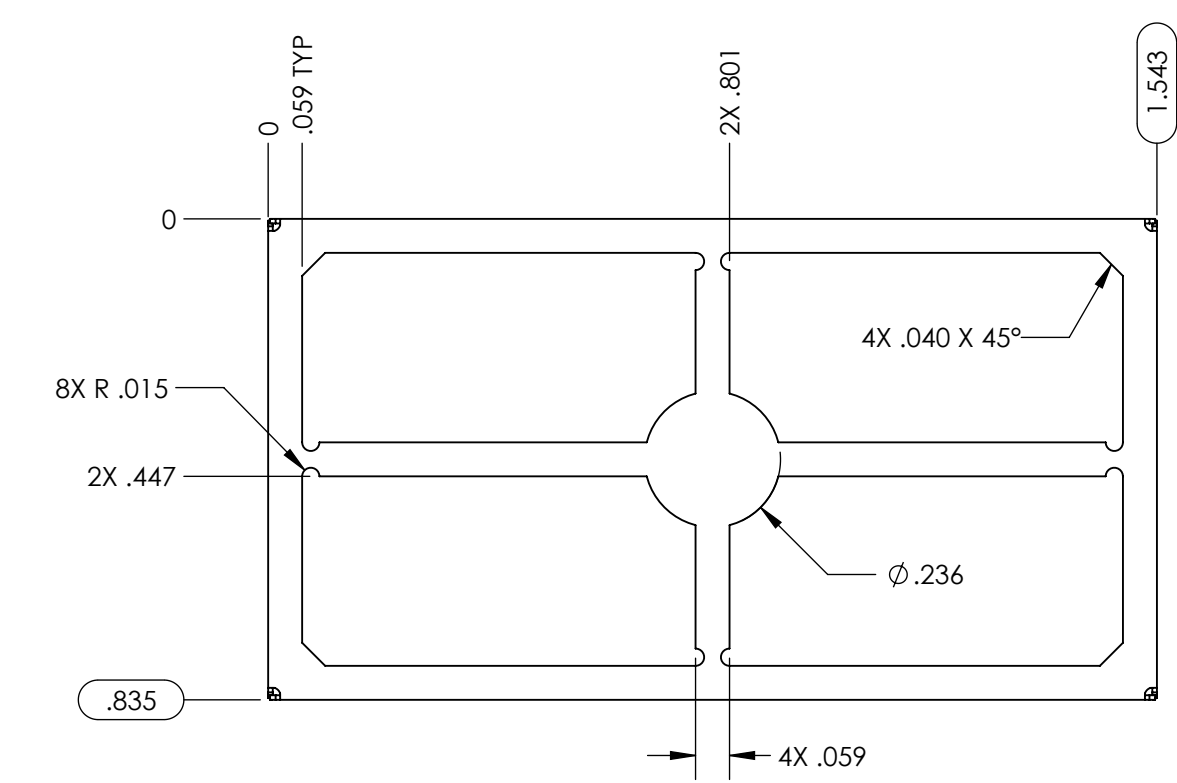
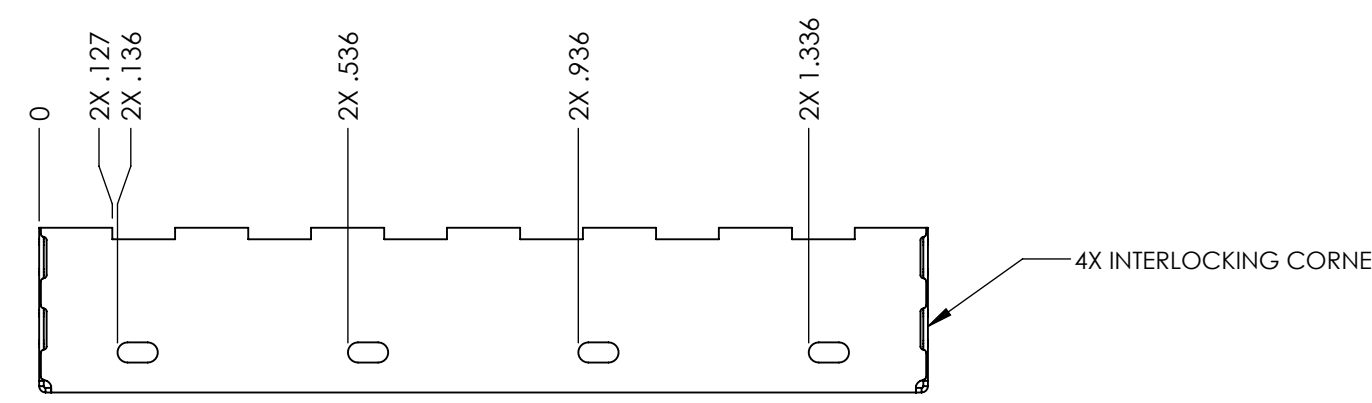

FORMED FRAME

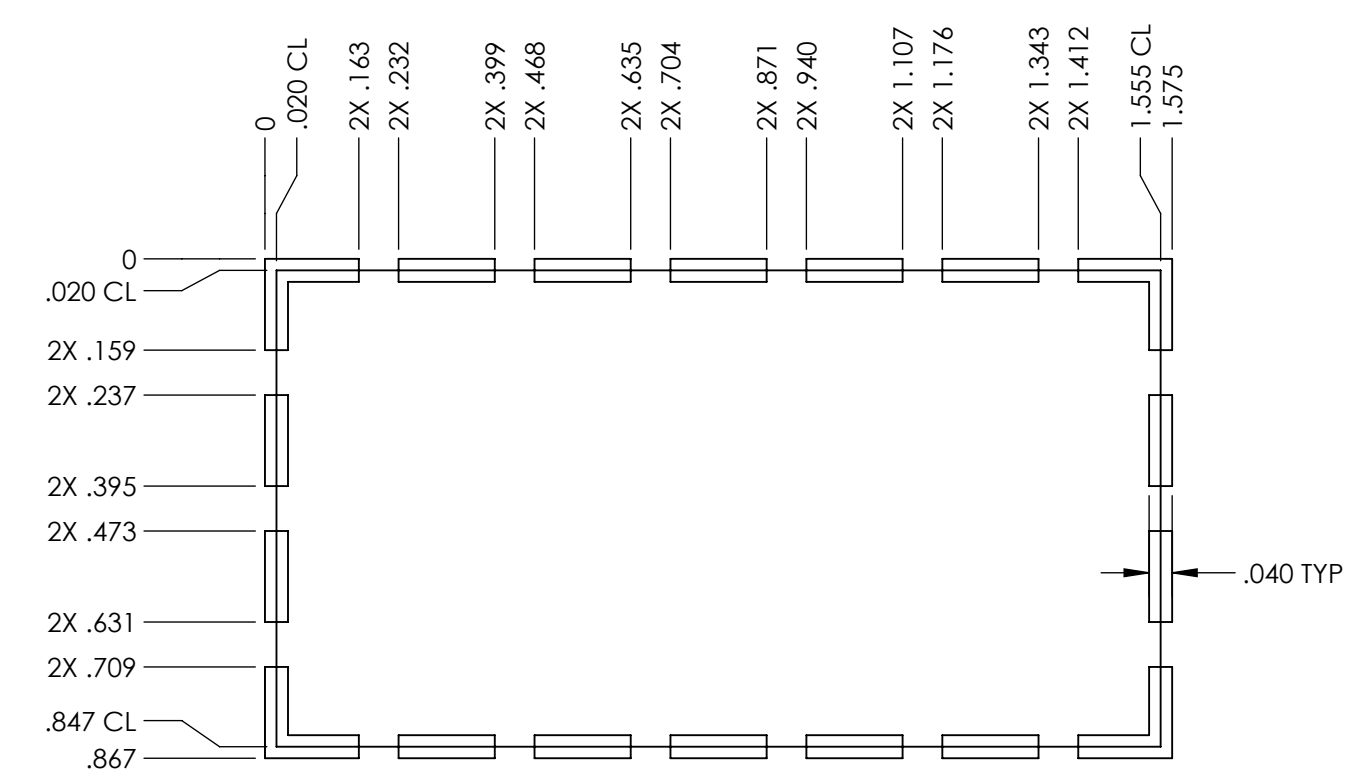
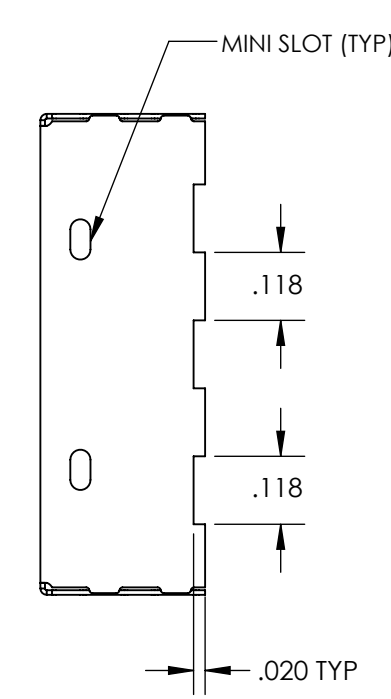

TRACE PATTERN

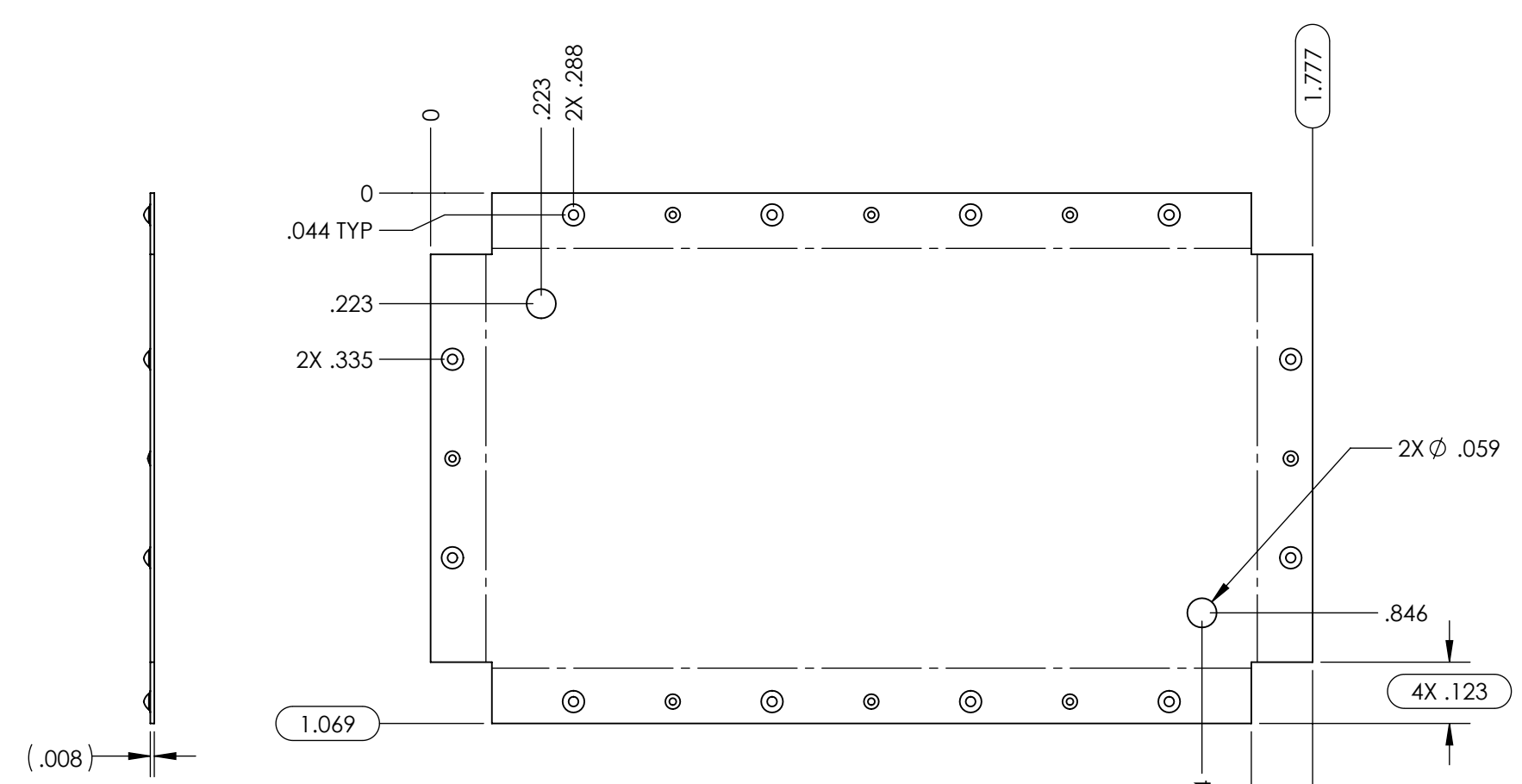

COVER BLANK

(.008)

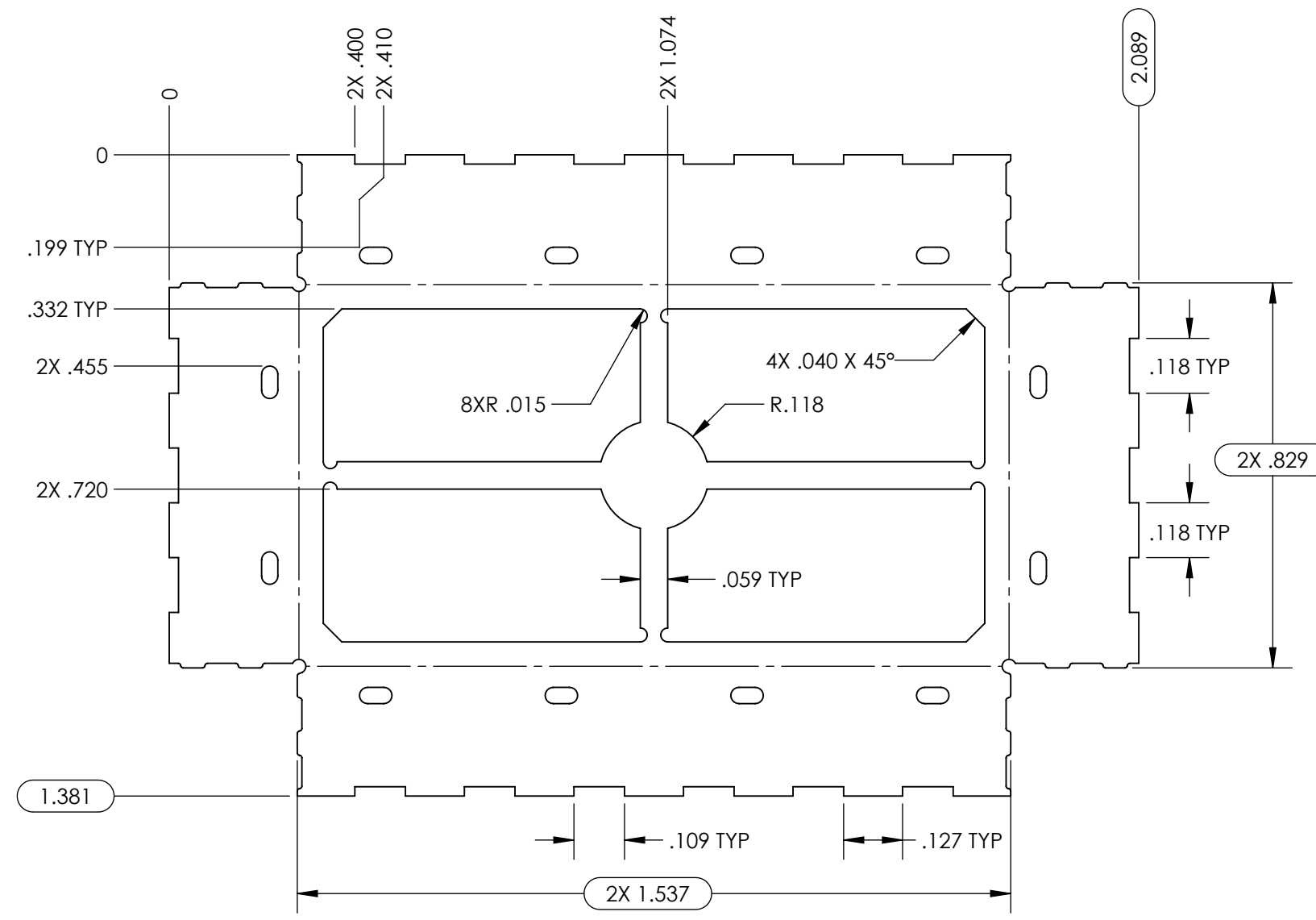

FRAME BLANK

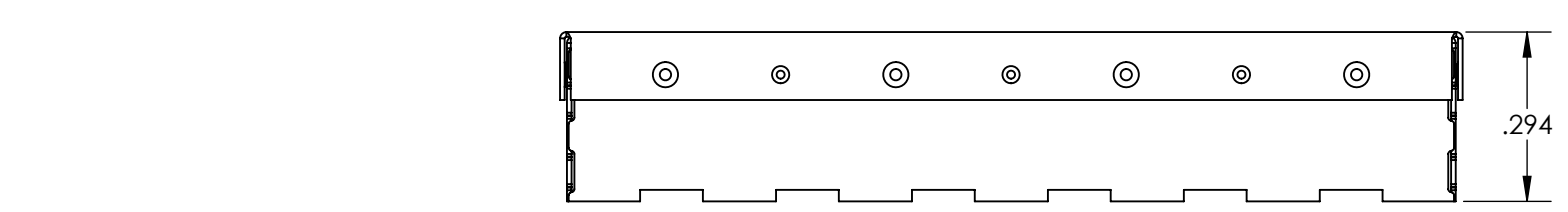
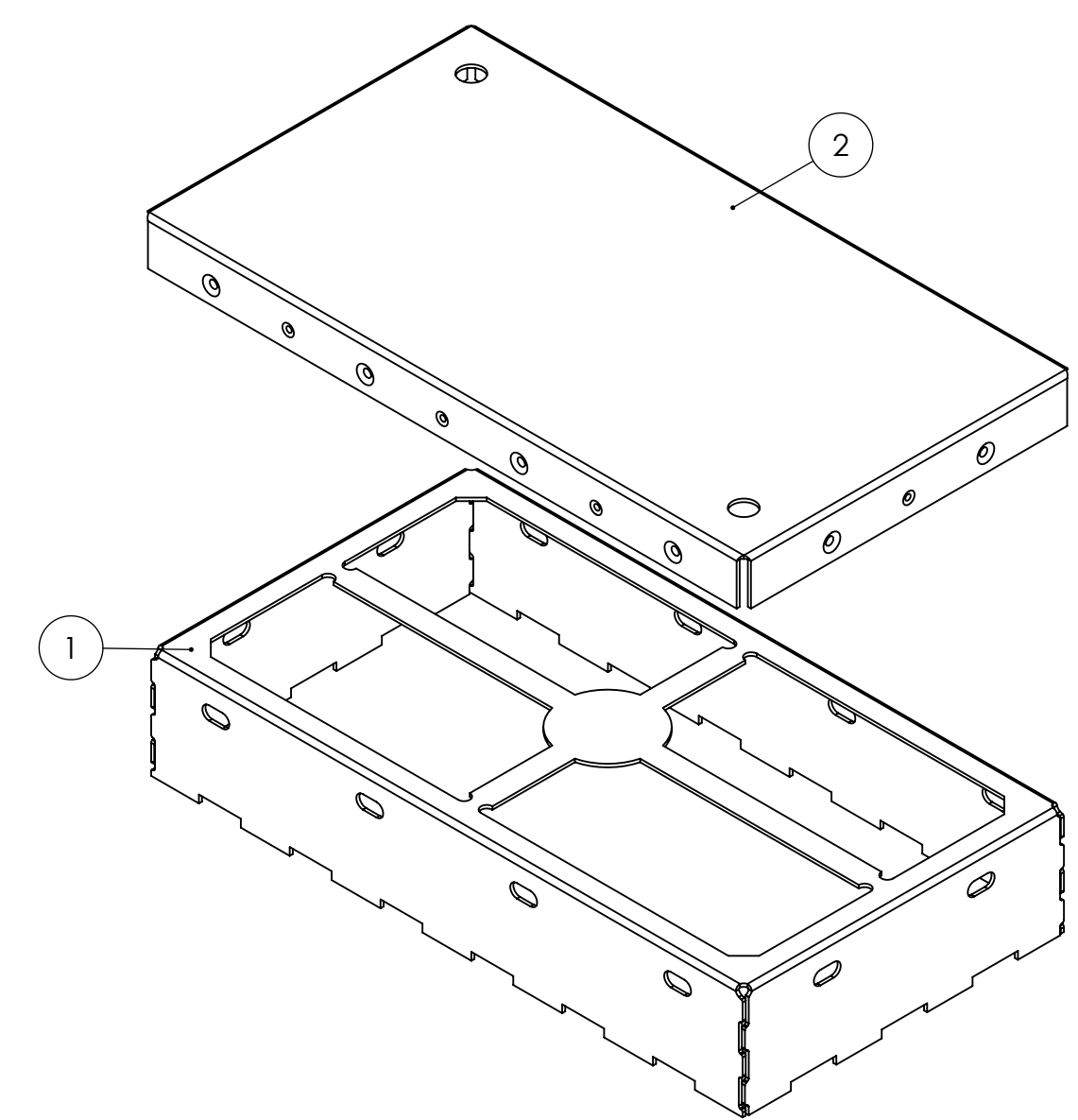

ASSEMBLY

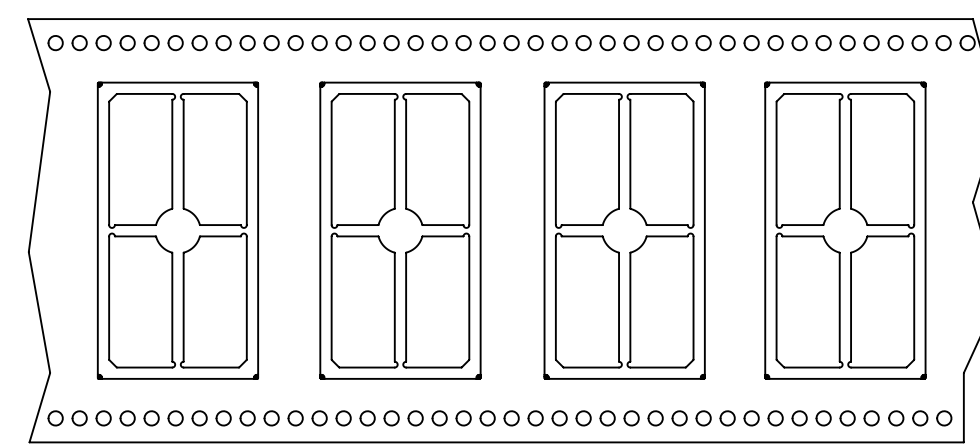

CARRIER TAPE

CARRIER TAPE SPECIFICATIONS						
PART NUMBER	DESCRIPTION	OVERALL DIMENSIONS	OVERALL HEIGHT	CARRIER TAPE WIDTH	CARRIER TAPE PITCH	PARTS PER REEL
SMS-456-N-F	FRAME	0.835 X 1.543 [21.21 X 39.19]	.286 [7.26]	56 mm	28 mm	280
SMS-456-N-C	COVER	0.859 X 1.567 [21.82 X 39.80]	.118 [3.00]	N/A	N/A	BULK PACK

THIS DOCUMENT CONTAINS PROPRIETARY INFORMATION OWNED BY LEADTECH OR DEVELOPED AT ITS OWN PRIVATE EXPENSE AND MAY NOT BE USED, DUPLICATED OR DISCLOSED IN WHOLE OR IN PART FOR ANY PURPOSE INCLUDING DESIGN, MANUFACTURE OR PROCUREMENT WITHOUT THE WRITTEN PERMISSION OF LEADTECH. LEADTECH DOES NOT GUARANTEE OR WARRANT THE PERFORMANCE CHARACTERISTICS.

ITEM NO.	PART NUMBER	DESCRIPTION	QTY.
1	SMS-456-N-F	FRAME	1
2	SMS-456-N-C	COVER	1

UNLESS OTHERWISE SPECIFIED:
- ALL DIMENSIONS ARE IN INCHES
- PART SHALL BE FREE OF BURRS AND SHARP EDGES
- ALL DIMENSIONS SHOWN APPLY AFTER PLATING AND COATINGS
- ROHS COMPLIANT PER EU DIRECTIVE 2011/65/EU
- POI = POINT OF INTERSECTION

THIRD ANGLE PROJECTION
ANGLES +/- 2°

DRAWN BY: SDH
DATE: 2016-09-19
APPROVED BY:

SCALE: 3:1
CAGE CODE: 4J674
SHEET: 1 OF 1

LEADER TECH
a HEICO company
The Leading Edge in EMI Shielding Technology

TITLE: SURFACE MOUNT SHIELD
REV: A1
D SMS-456-N-MFG A1