

NOTES:

1. ASSURE ASSEMBLY CAPABILITY BY MATCHING WITH MATING PART

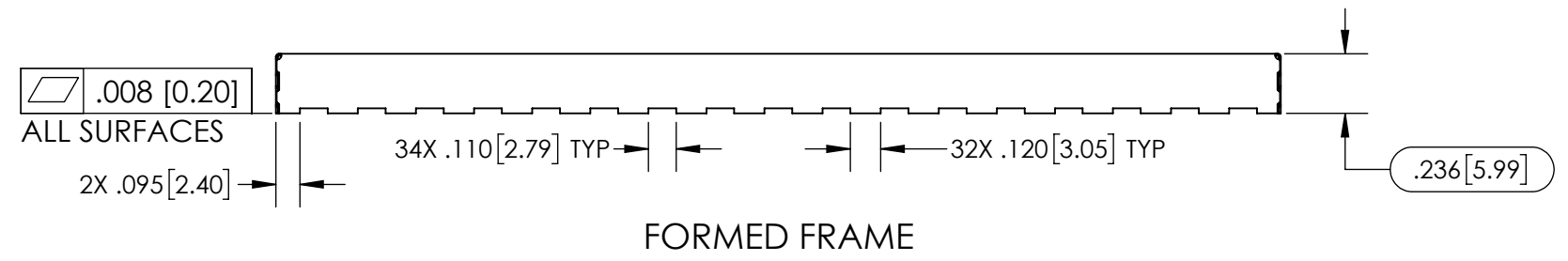

CARRIER TAPE SPECIFICATIONS					
PART NUMBER	OVERALL DIMENSIONS	OVERALL HEIGHT	CARRIER TAPE WIDTH	CARRIER TAPE PITCH	PARTS PER REEL
SMS-363-N	1.805 X 3.979 [45.85 X 101.07]	.236 [5.99]	120 mm	56 mm	130

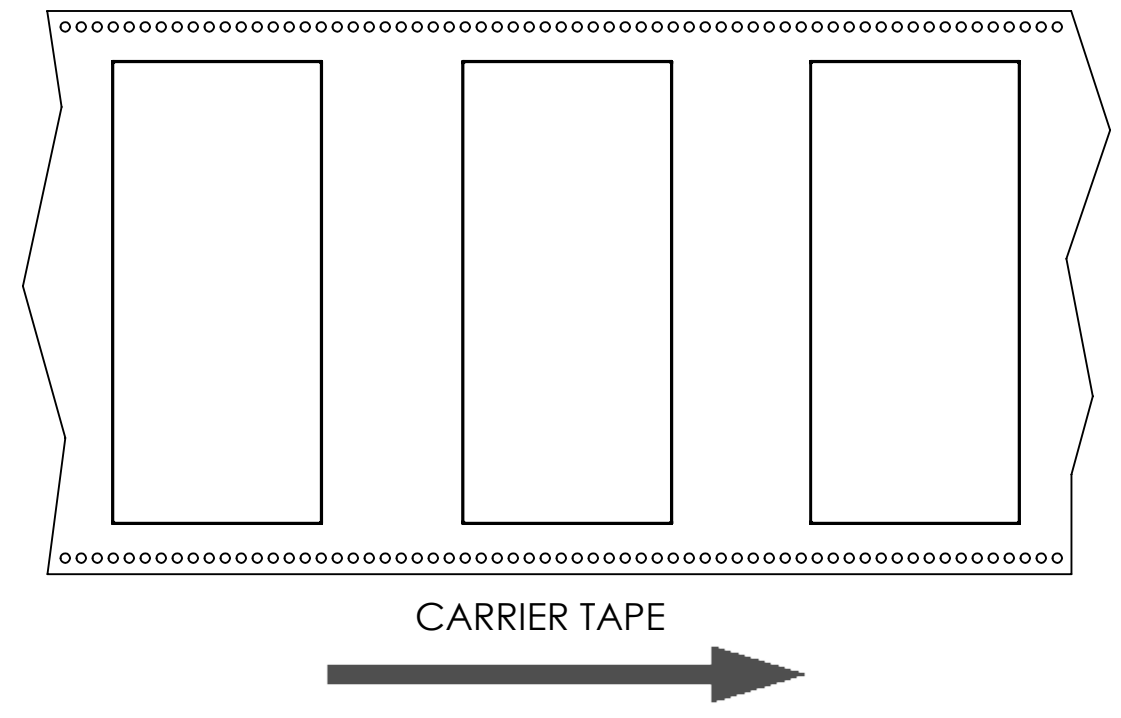
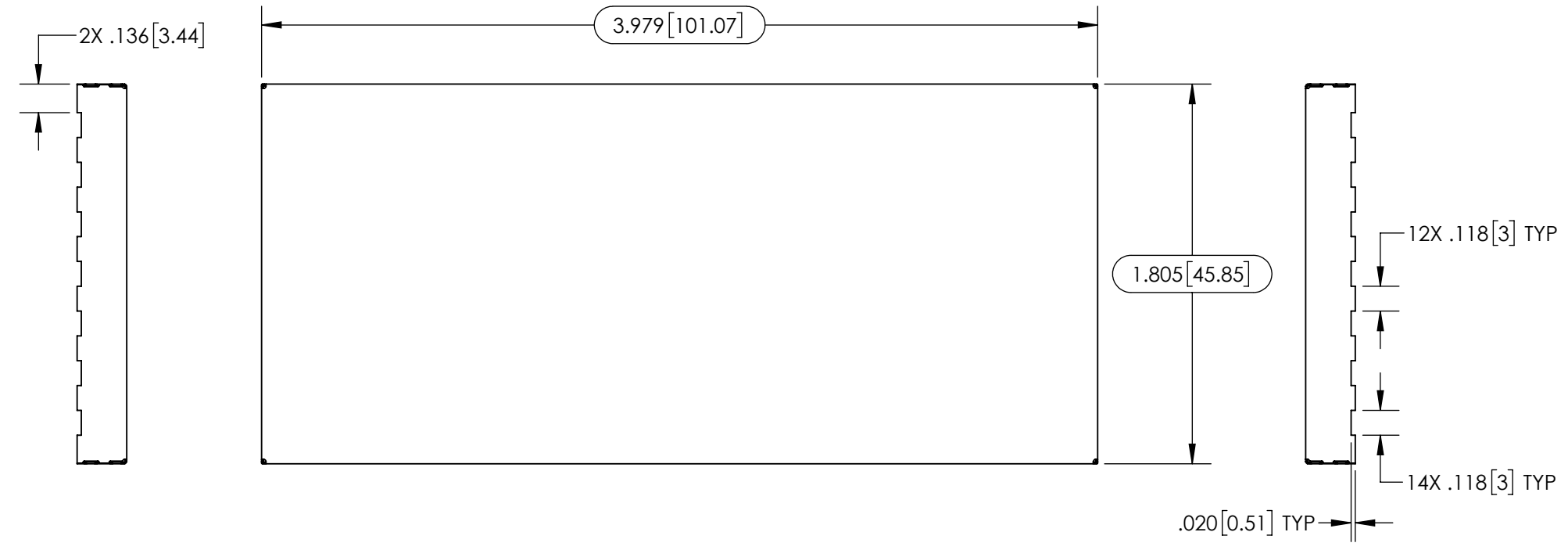
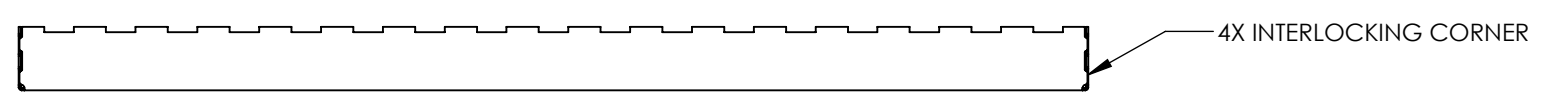
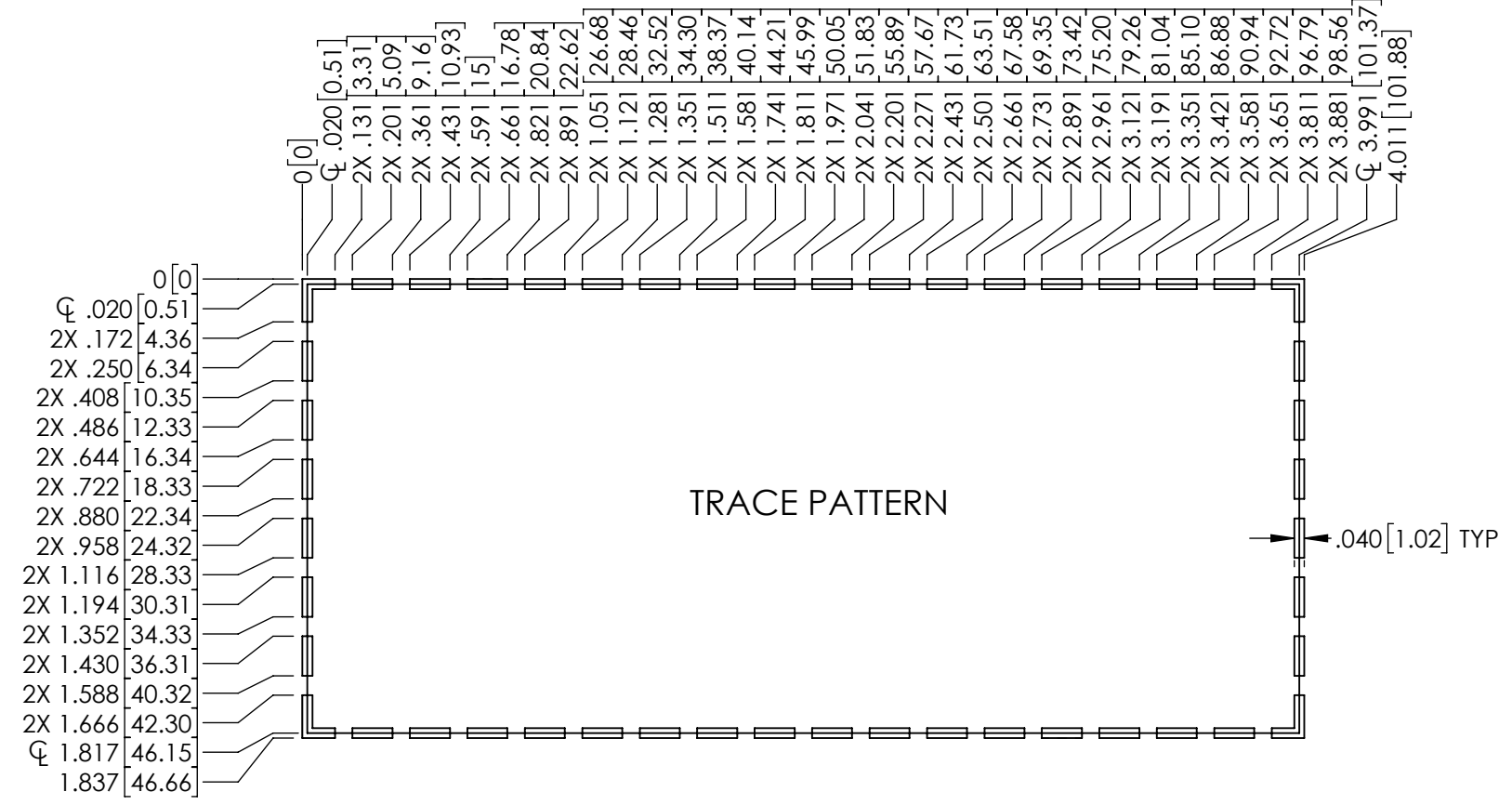
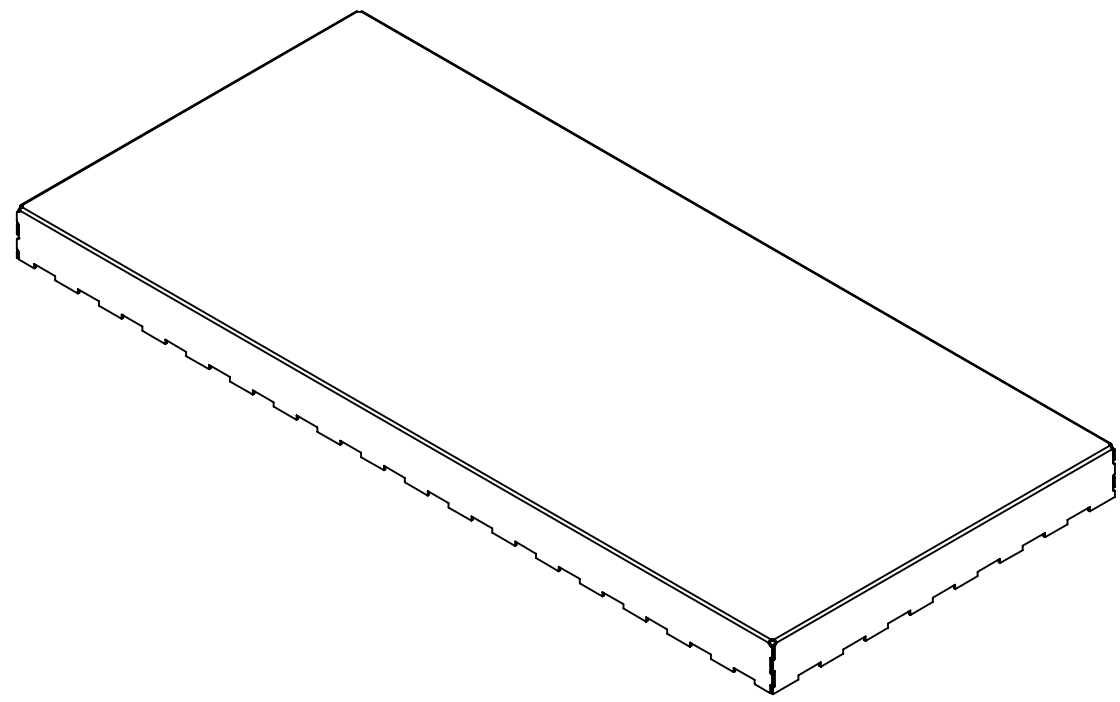

UNLESS OTHERWISE SPECIFIED:
 - ALL DIMENSIONS ARE IN INCHES
 - PART SHALL BE FREE OF BURRS AND SHARP EDGES
 - ALL DIMENSIONS SHOWN APPLY AFTER PLATING AND COATINGS
 - RoHS COMPLIANT PER EU DIRECTIVE 2011/65/EU
 - POI = POINT OF INTERSECTION

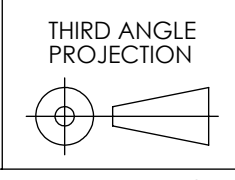

LEADER TECH
 a HEICO company
The Leading Edge in EMI Shielding Technology

TITLE: **SURFACE MOUNT SHIELD**

SCALE: **C** DWG. NO.: **SMS-363-N** REV: **A**

SCALE: 1.4:1 CAGE CODE: 4J674 SHEET: 1 OF 1

THIS DOCUMENT CONTAINS PROPRIETARY INFORMATION OWNED BY LEADERTECH, OR DEVELOPED AT ITS OWN PRIVATE EXPENSE, AND MAY NOT BE USED, DUPLICATED OR DISCLOSED IN WHOLE OR IN PART FOR ANY PURPOSE INCLUDING DESIGN, MANUFACTURE OR PROCUREMENT WITHOUT THE WRITTEN PERMISSION OF LEADERTECH. LEADERTECH DOES NOT GUARANTEE OR WARRANT THE PERFORMANCE CHARACTERISTICS.

DRAWN BY: **JG** 2016-09-27 APPROVED BY:

FINISH: **N/A**

MATERIAL: **.008" [0.20] C77000 H02 (ALLOY 770)**